

Bauanleitung Assembly Instructions Notice de montage Istruzioni di montaggio Instrucciones de montaje

Erforderliche Materialien für den Zusammenbau
Required materials for assembly
Matériaux nécessaires à l'assemblage
Materiali richiesti per il montaggio
Materiales necesarios para el montaje



Bastelmesser
Hobby knife
Cutter
Cuchillo afilado
Taglierino affilato



Lineal
Ruler
Règle
Gobernante
Righello



Bleistift
Pencil
Crayon
Lápiz
Matita



Holzleim
Wood Glue
Colle à bois
Pegamento de madera
Colla per legno



Schere
Scissors
Paire de ciseaux
Tijeras
Forbici



Kreppklebeband
Masking Tape
Ruban de masquage
Cinta adhesive
Nastro adesivo



Schleifpapier
Sandpaper
Papier de verre
Papel de lija
Carta abrasiva



Lack
Paint
Peinture
Pintura
Vernice



Kunststoffkleber
Plastic Cement
Colle plastique
Pegamento plástico
Colla di plastica

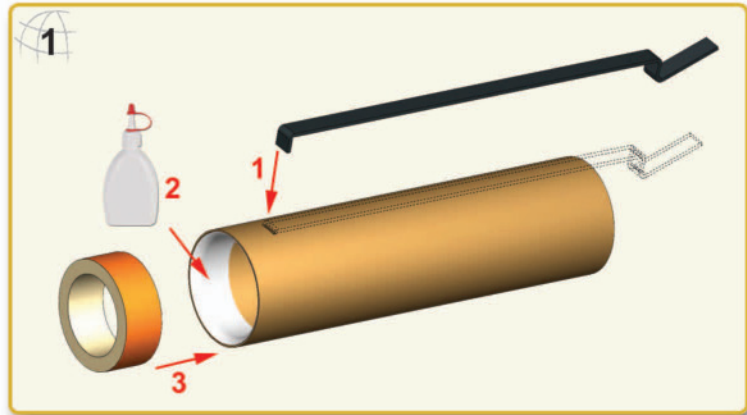

Das kurze Ende vom Motorhaltebügel in den Schlitz des Motorrohres drücken. Holzleim entlang der Innenseite des Motorrohres wie abgebildet auftragen. Den roten Schubring hineinschieben bis dieser am Motorbügel anliegt.

Attach motor clip through the small slit in the motor tube. Apply wood glue around inside edge of motor tube as shown. Insert red thrust ring into motor tube and position until seated against the motor clip.

Glisser le crochet de retenue du moteur à travers la petite fente présente dans le tube. Appliquer de la colle de bois à l'intérieur du tube support-moteur comme indiqué. Insérer l'anneau de blocage rouge dans le tube jusqu'à ce qu'il appuie contre le clip de retenue du moteur.

Adapte el clip del motor a través de la pequeña abertura en el tubo de motor y envolver un trozo de cinta alrededor del tubo motor para mantener el clip de motor en su lugar. Aplique el pegamento de madera por el interior del borde del tubo del motor como se muestra. Inserte el anillo de presión rojo en el tubo del motor y la posición hasta que se asiente contra el clip del motor.

Inserite la clip fermamotore attraverso la piccola fessura praticata nel tubo di supporto del motore, e tenetela in posizione con un pezzetto di nastro adesivo. Applicate della colla per legno all'interno del bordo del tubo di supporto del motore, come illustrato. Inserite l'anello reggispinta rosso nel tubo e spingetelo fino a quando si ferma contro la clip che avete appena inserito.

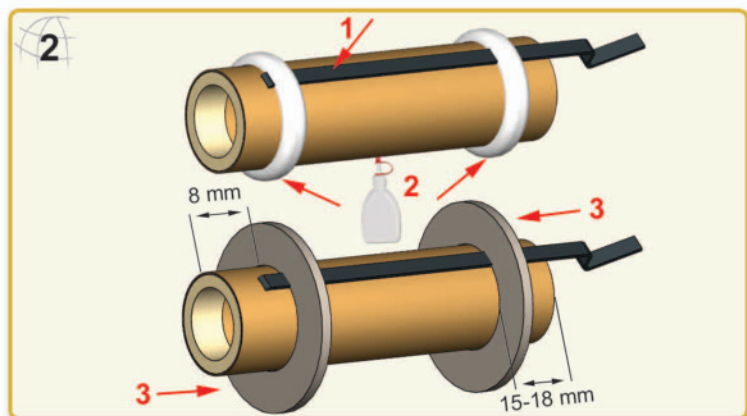

Eine umlaufende Raupe mit Klebstoff um das Motorrohr im Bereich des Haltebügels anbringen. Wie abgebildet einen auf das Motorrohr und über den Bügel schieben. Dann eine zweite Klebstoff-Raupe am hinteren Ende des Motorrohres anbringen und den zweiten Zentrierung aufschieben bis es 15-18 mm vom hinteren Ende entfernt ist. Um die Motorhalterung abzuschließen, ist an beiden Zentrierungen von beiden Seiten eine Kehle aus Klebstoff anzubringen. Zum Trocknen beiseitelegen.

Apply a bead of glue around the motor tube in the area where the clip goes through the tube. Push a centering ring over the motor tube and the clip as shown. Then apply another bead of glue around the rear end of the motor tube and slide on the remaining centering ring until it is about 15-18 mm from the rear end. To complete the motor mount assembly, add a fillet of glue from each side of both centering rings and place aside to dry.

FR Appliquer un cordon de colle autour du tube dans la zone où le clip passe au travers. Glisser une bague de centrage sur le tube du moteur, chevauchant le clip comme indiqué. Ensuite, appliquer un autre cordon de colle autour de l'extrémité arrière du tube et glisser la seconde bague de centrage alignée sur la première, positionnée à 15-18 mm de l'extrémité arrière. Pour compléter l'assemblage du support-moteur, ajouter un congé de colle de chaque côté de deux bagues de centrage et laisser sécher de côté.

ES Aplique un cordón de pegamento alrededor del tubo del motor en el área donde el clip pasa a través del tubo. Empuje un anillo de centrado sobre el tubo del motor y el clip como se muestra. A continuación, aplique otra gota de cola alrededor del extremo trasero del tubo del motor y deslícela sobre el anillo de centrado restante hasta que esté a unos 15-18 mm del extremo trasero. Para completar el conjunto del montaje del motor, agregue un filete de pegamento de cada lado de los dos anillos de centrado y póngalos a un lado para secar.

IT Applicare uno strato di colla attorno al tubo di supporto del motore nella zona in cui la clip si inserisce nel tubo stesso. Inserite un anello di centraggio in modo che passi sopra il tubo e la clip, come mostrato. Quindi applicate un altro filetto di colla intorno all'estremità posteriore del tubo, all'esterno, e fategli scorrere sopra il restante anello di centraggio finché arriva a circa 15-18 mm dall'estremità posteriore. Per completare il montaggio del gruppo motore, aggiungete un filetto di colla su ciascun lato di entrambi gli anelli di centraggio e mettete il tutto da parte ad asciugare.

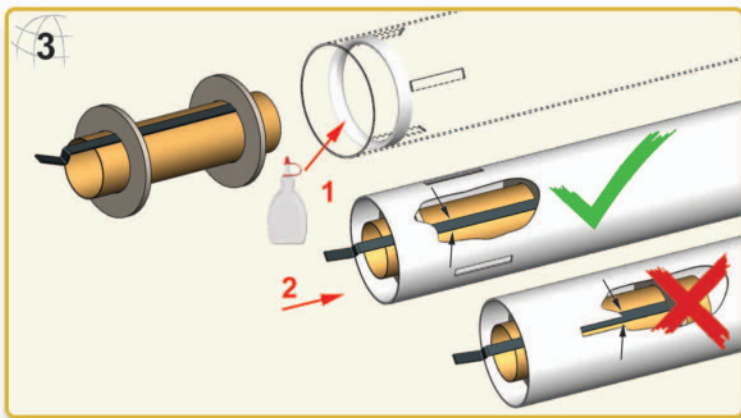

DE Die Motorhalterung in das geschlitzte Körperrohr schieben, bis Motorrohr und Körperrohr bündig sind, dabei beachten, dass der Motorhaken nach hinten heraus zeigt wie abgebildet. Ebenfalls sollte der Motorhaken zwischen zwei der Schlitze im Körperrohr ausgerichtet sein, da es sonst bei der Montage der Flossen stören wird!

UK Slide motor mount assembly with motor hook facing out in to the slotted body tube as pictured. Be sure that motor mount tube and body tube are flush and check that the motor hook is oriented between two of the slots of the body tube. The hook should not be directly beneath a slot, or else it will interfere when assembling the fins!

FR Appliquer de la colle dans le tube fendu de la fusée. Glisser le support-moteur dans le tube. S'assurer que le support moteur et le tube sont bien alignés et vérifier que le crochet de retenue du moteur se trouve bien entre deux fentes du tube. Le crochet ne doit pas se trouver directement sous une fente pour ne pas gêner le montage des ailettes.

ES Deslice el conjunto del montaje del motor con el gancho del motor mirando hacia el tubo de cuerpo ranurado como se ilustra. Asegúrese de que el tubo de montaje del motor y el tubo del cuerpo estén a ras y compruebe que el gancho del motor esté orientado entre dos de las ranuras del tubo del cuerpo. ¡El gancho no debe estar directamente debajo de una ranura, o bien interferirá al montar las aletas!

IT Applicare della colla all'interno del tubo scanalato del modello. Inserite l'insieme del supporto motore come da figura, con il gancetto fermamotore verso il tubo fusoliera. Assicuratevi che il tubo di supporto del motore e la fusoliera siano a filo e controllate che il gancetto fermamotore sia posizionato tra due delle scanalature del tubo principale. Il gancetto non deve stare direttamente sotto una scanalatura, altrimenti impedisce il montaggio delle alette!

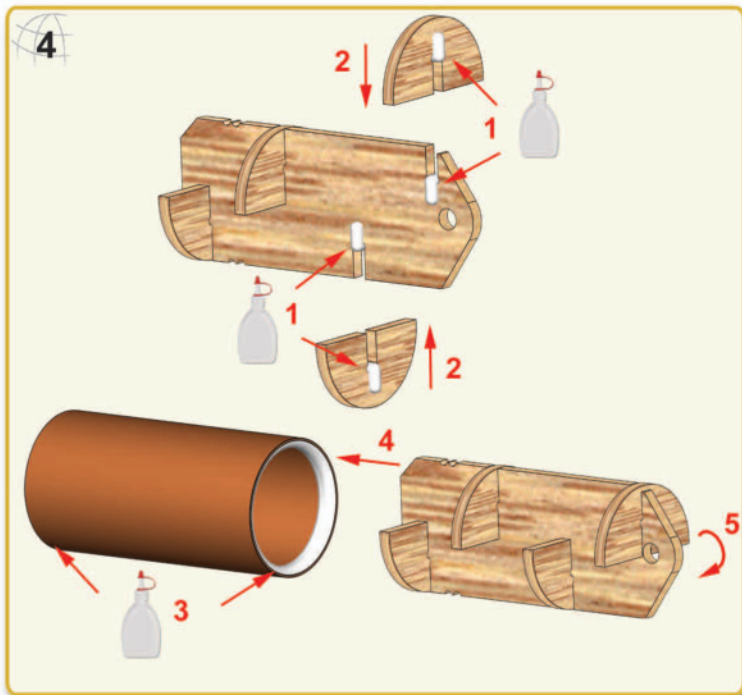

DE Die Halbkreis-Scheiben an der zentralen Stütze wie abgebildet kleben. Dann in jedem Ende des Rohr-Kupplers eine Klebstoff-Raupe auftragen. Beim Einführen des Fallschirm-Schutzes gleichzeitig um eine Umdrehung drehen.

UK Glue the half-circular discs to the central column as pictured. Then apply a bead of glue inside both ends of the tube coupler. When inserting the baffle in to the coupler, do a twisting motion of one rotation at the same time.

FR Collez les couples en demi-lune sur l'âme centrale comme sur la photo puis appliquez un cordon de colle à l'intérieur des deux extrémités du tube de jonction. Lors de l'insertion de la chicane dans le tube de jonction, effectuer un mouvement de torsion et de rotation en même temps.

ES Pegue los discos semicirculares a la columna central como se ilustra. A continuación, aplique un cordón de pegamento dentro de ambos extremos del acoplador de tubo. Al insertar el deflector en el acoplador, haga un movimiento de torsión de una rotación al mismo tiempo.

IT Incollate i dischi semi-circolari al supporto centrale, come da figura. Quindi applicate un filetto di colla all'interno di entrambe le estremità del tubo accoppiatore. Inserite l'insieme appena ottenuto (deflettore dei gas) nell'accoppiatore, compiendo nello stesso momento un movimento rotatorio.

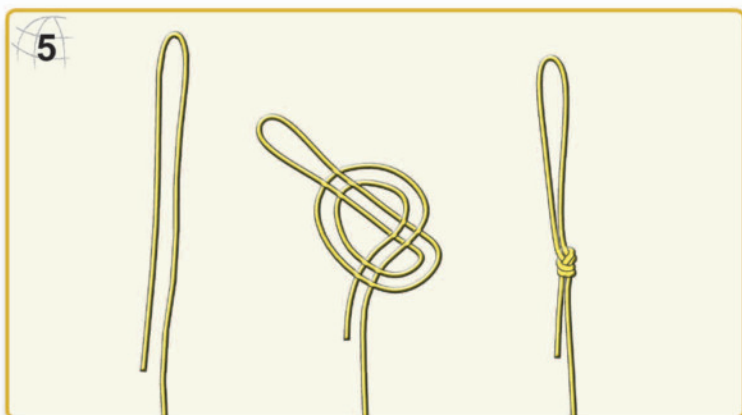

 In die Kevlar-Schnur eine Schlaufe binden.

 Tie a noose on one end of the Kevlar cord.

 Effectuer un nœud en queue de vache à une extrémité du cordon de Kevlar.

 Ate un nudo en un extremo del cordón de Kevlar.

 Formate un cappio ad un'estremità del cavo di Kevlar.

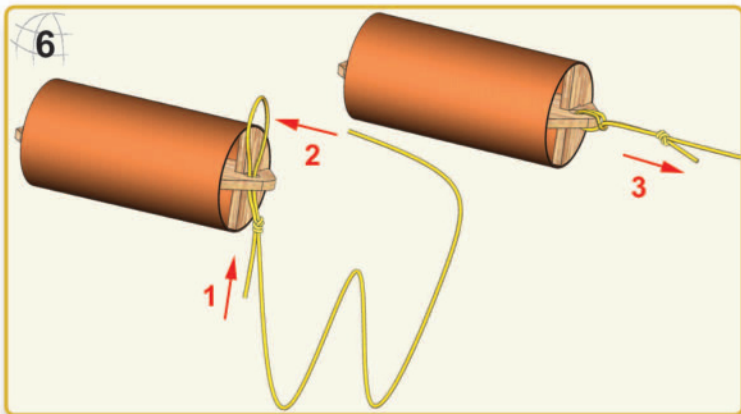

 Die Schlaufe mit einem Ankerstich an die Öse des Fallschirmschutzes befestigen.

 Attach the noose to the baffle with a cow hitch as pictured.

 Passer la boucle dans le trou du déflecteur puis glisser l'extrémité du cordon dedans pour fermer le nœud comme indiqué.

 Fije el lazo al deflector con un enganche de vaca como se ilustra.

 Fissate il cappio nel foro del deflettore con un nodo, come nella immagine.

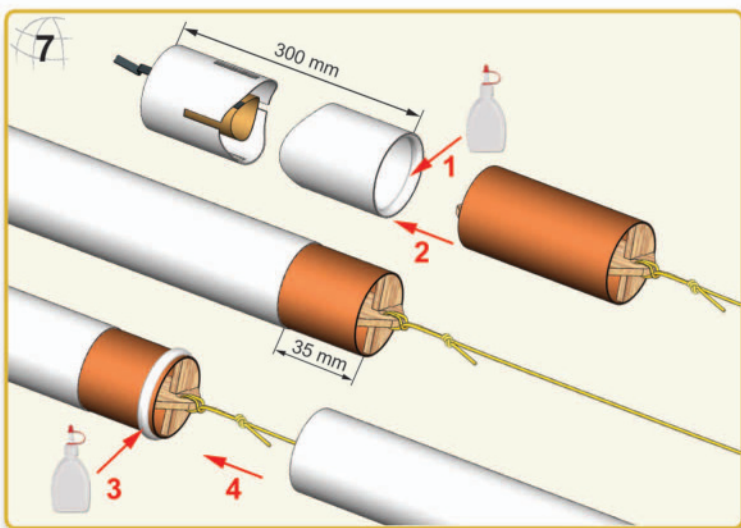

 Den fertigen Fallschirmschutz im unteren Körperrohr wie abgebildet einkleben, jedoch nur zur Hälfte einschieben. Danach das mittlere Rohr ankleben, überschüssigen Klebstoff sofort abwischen.

 Now glue the completed baffle in to the lower body tube as pictured, but leave half of it sticking out. Then glue on the middle body tube; immediately wipe off any excess glue from the body tube.

 Maintenant, coller la chicane complète dans le tube inférieur de la fusée comme sur la photo, mais laisser la moitié de celui-ci dépasser. Ensuite, coller sur le tube supérieur de la fusée. Essayez immédiatement tout excès de colle sur le corps de la fusée.

 Ahora pegue el deflector completo en el tubo inferior del cuerpo tal como se muestra en la figura, pero deje la mitad de él sobresaliendo. Luego pegue el tubo del cuerpo medio; Limpie inmediatamente cualquier exceso de pegamento del tubo del cuerpo.

 Ora incollate il gruppo deflettore completo nella parte inferiore del corpo, come da figura, ma lasciate fuori la metà di esso. Incollate la parte superiore del corpo sopra questa metà libera dell'accoppiatore; rimuovete immediatamente la colla in eccesso dal tubo fusoliera.

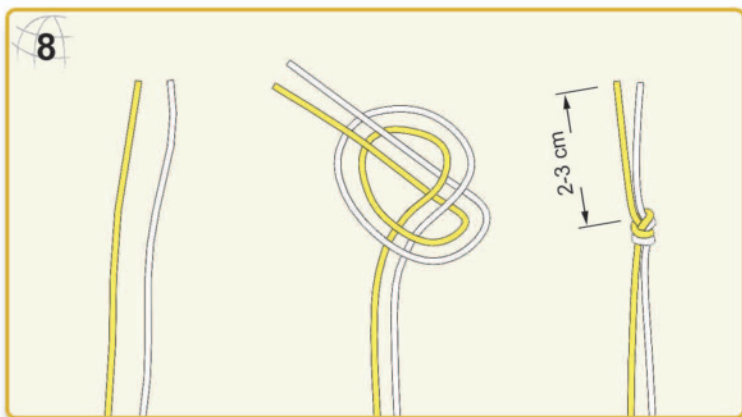

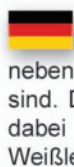
 Die Kevlarschnur und das elastische Schockband so nebeneinander legen, dass die beiden Enden miteinander bündig sind. Die beiden Schnüre in einem Knoten mit einander verbinden, dabei ca. 2-3 cm zum Ende Platz lassen und mit einem Tropfen Weißleim sichern.

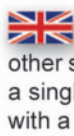
 Place the Kevlar cord and the elastic shock cord next to each other so that the ends are even with each other. Tie them together with a single parallel overhand knot 2-3 cm from the end. Secure the knot with a spot of white glue.

 Placez le fil de Kevlar et le cordon élastique côte à côte de sorte que les extrémités se trouvent au même niveau. Les nouer ensemble à 2-3 cm de l'extrémité. Condamner le nœud avec un point de colle blanche.

 Colocar el cable de Kevlar y el cable de plástico elástico de manera que los dos extremos esten uno con el otro. Atarlas con un solo nudo paralelo 2-3 cm del extremo. Asegure el nudo con un poco de pegamento blanco.

 Prendete le estremità del cavetto elastico e del cavo in Kevlar e mettetele una accanto all'altra in modo che siano pari. Legatele assieme con un unico nodo semplice a 2-3 cm dall'estremità. Fissate il nodo con una goccia di colla.

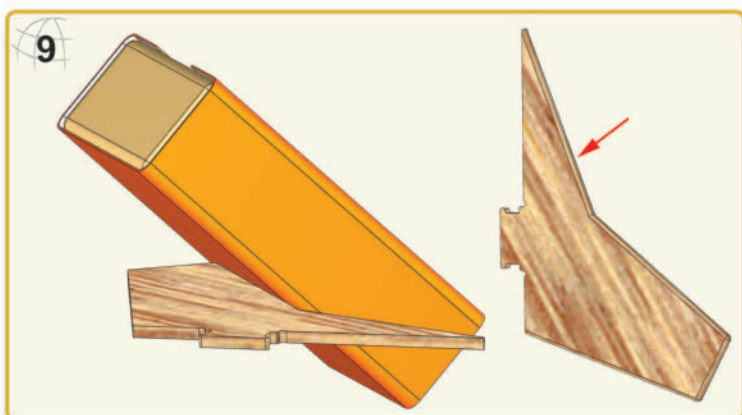

 An dieser Stelle kann man entscheiden ob die Kanten eckig bleiben, gerundet werden, eine Fase, oder sogar eine Stromlinienform erhalten. Am besten geht es mit einem Schleifklotz.

 At this stage you can choose whether you want to leave the fin edges square, make them rounded, bevel them or even streamline them. Use a sanding block.

 A ce stade, vous pouvez choisir de laisser le bord des ailettes saillant, de l'arrondir, de le biseauter ou même de le profiler. Utiliser une cale à poncer.

 En esta etapa puede elegir si desea dejar los bordes de las aletas cuadradas, hacerlas redondeadas, biselarlas o incluso optimizarlas. Utilice un bloque de lijado.

 A questo punto è possibile scegliere se si desidera lasciare le alette così come sono, oppure arrotondare o smussare il profilo, o addirittura profilarlo a sezione alare. Per queste operazioni usate un blocco per levigatura.

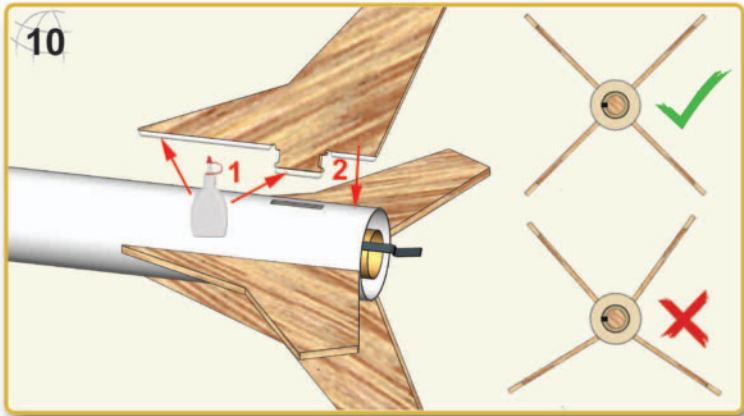

 Etwas Holzleim entlang der Wurzel und Lasche einer Flosse auftragen und durch einen Schlitz im Körperrohr stecken. Darauf achten, dass jede Flosse gut aufsitzt und zwecks guter Haftung im korrekten Winkel zum Rohr aufgeklebt wird. Mit jeder Flosse wiederholen. Klebstoff trocknen lassen.

 Apply some wood glue along the root edge and tab of each fin and stick them in to the slots as pictured. Make sure each fin is seated firmly and at the correct angle on to the body tube for proper adhesion. Repeat with each fin. Let the glue dry.

 Appliquer un peu de colle à bois le long du bord de la racine et l'onglet de chaque ailette et les coller dans les fentes comme illustré. Assurez-vous que chaque ailette est assis fermement et à l'angle correct sur le tube du corps pour une bonne adhérence. Répéter l'opération avec chaque ailette. Laisser sécher la colle.

 Aplique un poco de pegamento de madera a lo largo del borde de la raíz y la lengüeta de cada aleta y pegarlas adentro a las ranuras según lo representado. Asegúrese de que cada aleta está firmemente asentada y en el ángulo correcto en el tubo del cuerpo para la adhesión adecuada. Repita con cada aleta. Deje que el pegamento se seque.

 Applicare un po' colla di legno lungo il bordo radice e scheda di ogni pinna e bastone li dentro alle slot come nella foto. Assicurarsi che ogni pinna sia inserito e con la giusta angolazione al tubo del corpo per una corretta adesione. Ripetere con ogni pinna. Lasciate asciugare la colla.

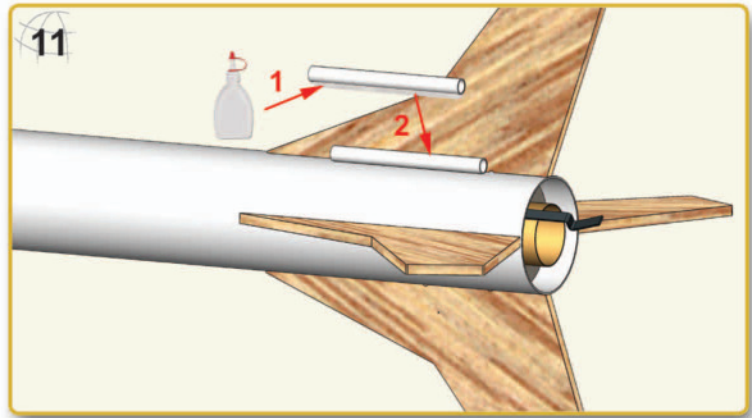

 Das Leitrohrchen in einer Ecke von Flosse und Körperrohr ankleben.

 Glue the launch lug in to the corner of one of the fins and body tube as shown.

 Coller le tube de guidage dans l'angle d'une ailette et du tube comme indiqué.

 Pegue la lengüeta de lanzamiento en la esquina de una de las aletas y tubo de cuerpo como se muestra.

 Incollate la guida di lancio nell'angolo tra una delle alette e il tubo fusoliera, come indicato.

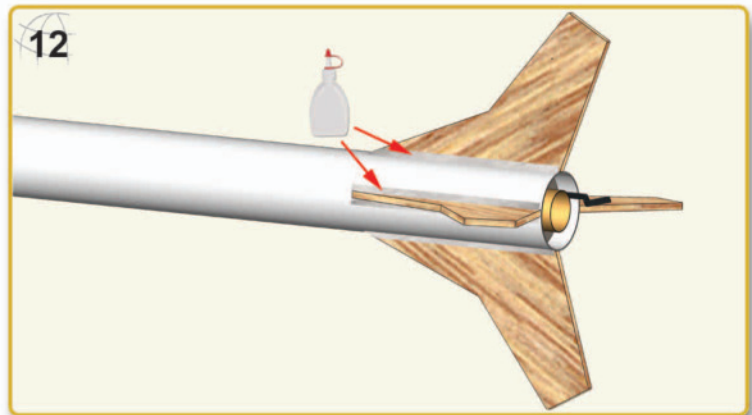

 Wenn der Klebstoff überall getrocknet ist, eine kleine Raupe mit Klebstoff in alle Fugen auftragen und mit einer feuchten Fingerkuppe glätten. Überschüssigen Klebstoff mit einem Papiertuch abwischen.

 After all glue has dried, apply a small bead of glue to all joints. Smooth the glue out with a wet fingertip. Wipe off the excess glue into a paper towel.

 Après séchage, appliquer une petite goutte de colle sur tous les joints. Lisser la colle avec un doigt mouillé. Essuyer l'excès de colle à l'aide d'une serviette en papier.

 Después de que todo el pegamento se haya secado, aplique un pequeño cordón de pegamento a todas las juntas. Suavizar el pegamento con un dedo mojado. Limpie el exceso de pegamento en una toalla de papel.

 Dopo che la colla si è asciugata, applicate ancora un filetto di colla lungo tutte le giunzioni tra alette e tubo fusoliera. Lisciate il filetto di colla con un dito inumidito. Pulite la colla in eccesso con un fazzoletto di carta.

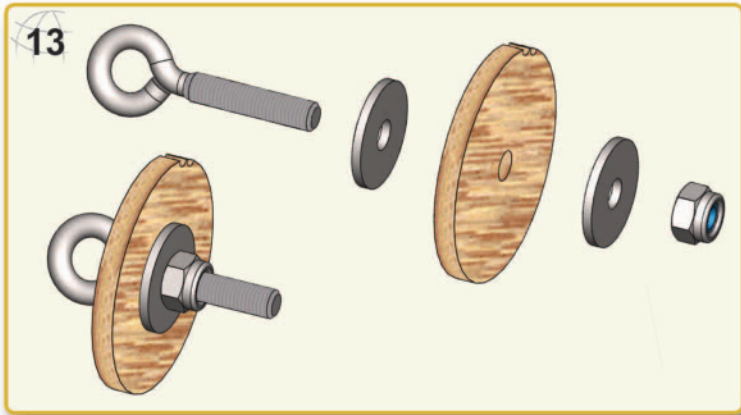

 Die Ösenschraube mit dem Spant wie abgebildet montieren.

 Assemble screw eye with bulkhead as pictured.

 Assemblez l'œillet avec la cloison comme illustré.

 Monte el perno con el mamparo como se ilustra.

 Montare il golfare con paratia come illustrato.

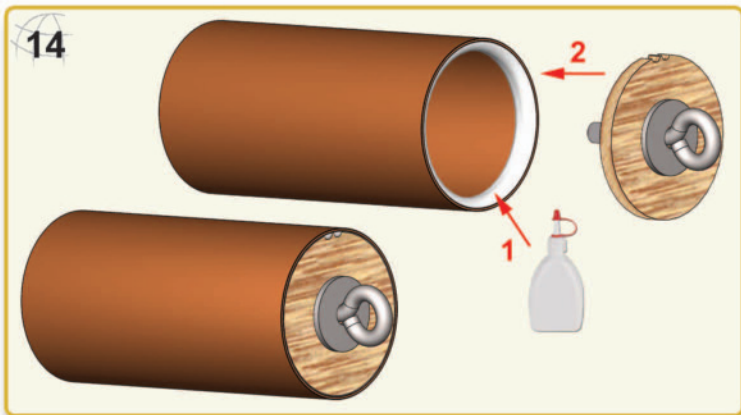

 Den montierten Spant in den verbleibenden Rohrverbinder wie abgebildet einkleben.

 Glue the assembled bulkhead in to the remaining coupler.

 Collez la cloison assemblée dans le coupleur restant.

 Pegue el mamparo montado en el acoplador restante.

 Colla paratia assemblato per la restante coppia.

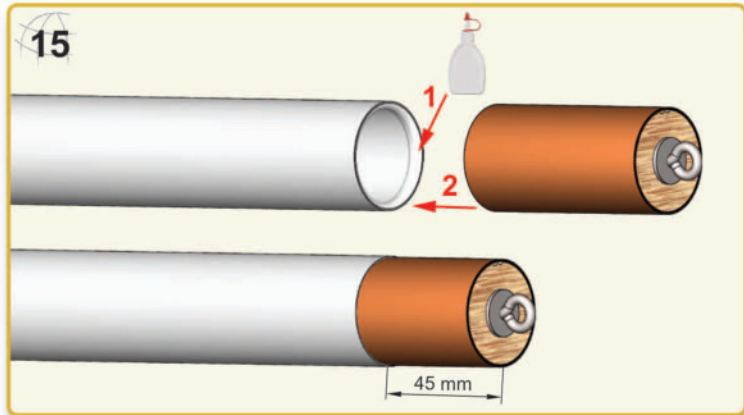

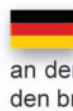
 Eine umlaufende Raube mit Klebstoff entlang der Innenseite an der vorderen Seite des verbleibenden Körperrohrs auftragen und den braunen Kuppler einschieben bis ca. 45 mm noch heraus ragen.

 Apply a bead of glue around the inside of the front end of the remaining body tube and slide in the brown coupler tube until 45 mm of it is still sticking out.

 Appliquez un cordon de colle à l'intérieur du tube restant et insérer le tube de coupleur brun jusqu'à ce que la 45 mm de celui-ci est toujours en dehors.

 Aplique un cordón de pegamento alrededor del interior de un extremo del tubo del cuerpo restante y deslízelo en el tubo marrón del acoplador hasta que 45 mm de éste todavía salga.

 Poi applicate uno strato di colla tutto intorno all'interno, e inserire il tubo accoppiatore marrone a corpo superiore, come da figura, ma lasciate fuori 45 mm di esso.

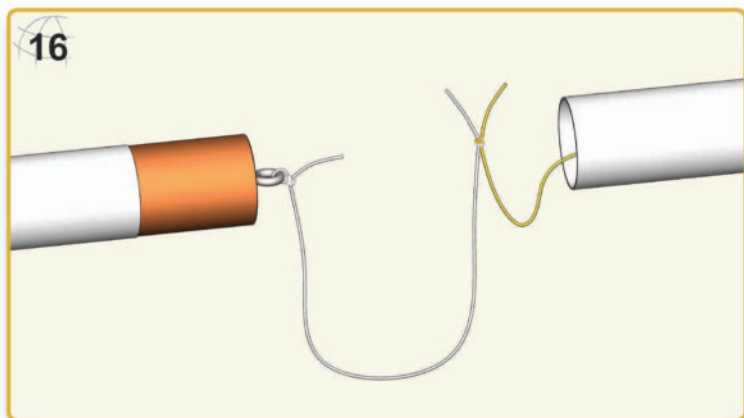

 Dann das Schockband mit einem Doppelknoten an die Ösenschraube festbinden.

 Tie the elastic shock cord to the eyebolt with a double knot.

 Attachez le cordon élastique à l'œillet.

 Ate el cordón de choque elástico al perno con un doble nudo.

 Quindi fissate l'altra estremità del cavetto elastico per l'occhiello, utilizzando due nodi semplici.

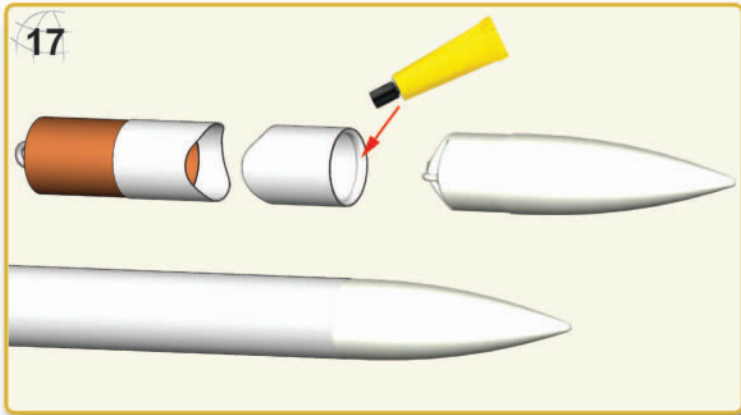

 Die Spitze mit Kunststoffkleber in das obere Rohr einkleben.

 Use plastic cement to glue the nose cone into the top of the upper body tube.

 Utilisez de la colle en plastique pour coller l'ogive dans l'autre extrémité du tube.

 Usar cemento de plástico para pegar el cono de ogiva en la parte superior del tubo del cuerpo.

 Utilizzare colla di plastica per incollare il ogiva a tubo superiore del corpo.

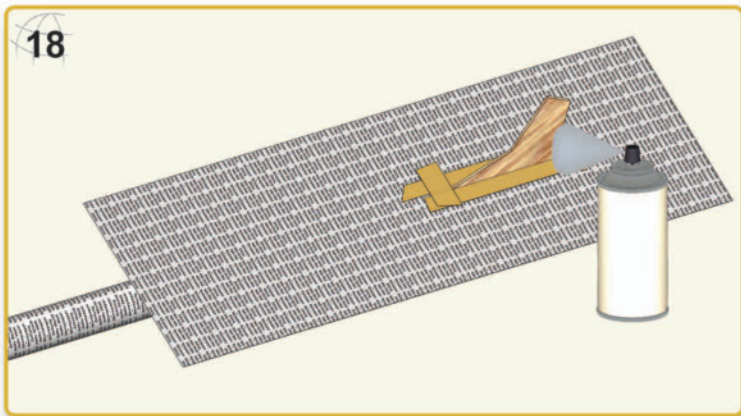

 Das Modell abschleifen, grundieren und entweder wie auf der Verpackung vorgeschlagen oder nach eigener Vorliebe lackieren. Die Flossen mit Kreppband und Zeitungspapier abdecken um sie in separaten Farben zu lackieren.

 Sand, prime and paint model as suggested on packaging or according to personal preference. Mask the fins with some masking tape and newspaper to paint them in separate colors.

 Sable, modèle premier et la peinture comme suggéré sur l'emballage ou selon vos préférences personnelles. Masquer les ailettes avec un peu de ruban de masquage et le journal de les peindre dans des couleurs distinctes.

 Arena, prima y pintar el modelo como se sugiere en el envase o de acuerdo a las preferencias personales. Enmascarar las aletas con un poco de cinta y el periódico para pintar en colores separados.

 Carteggiare tutto il modello con carta abrasiva fine (240) e coloratelo come suggerito sulla confezione, o in base alle vostre preferenze personali. Mascherate le alette con un po' di nastro adesivo e carta per dipingerle separatamente con colori diversi.

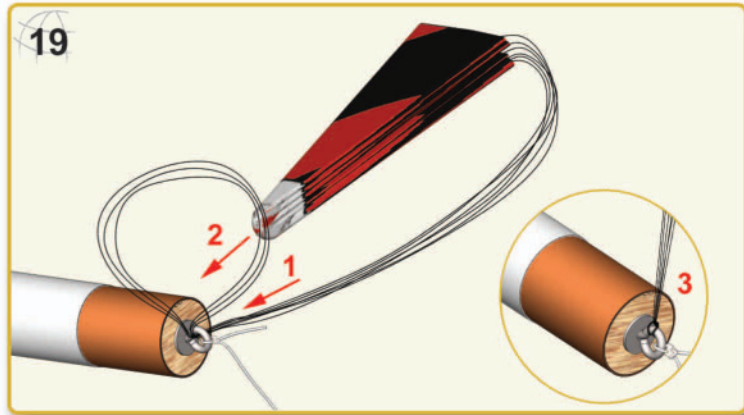

 Den Fallschirm gemäß der aufgedruckten Anleitung zusammenbauen. Fädeln Sie die drei Schlaufen der Fallschirmleinen durch die Ösenschraube und ziehen Sie durch diese gemeinsame Schlaufe den Fallschirm hindurch.

 Assemble parachute according to instructions printed on it. Pass the shroud line loops through the eyelet. Pass parachute through the loop ends and pull lines tightly against the eyelet.

 Assembler le parachute en suivant les instructions imprimées dessus. Passer la boucle des suspentes dans la vis à travers l'œillet. Passer le parachute dans la boucle et serrer les suspentes contre l'œillet.

 Ensamble el paracaídas según las instrucciones impresas en él. Pase los bucles de la línea de protección a través del ojal. Pase el paracaídas a través de los extremos del bucle y tire de las líneas firmemente contra el ojal.

 Assemblate il paracadute seguendo le istruzioni stampate su di esso. Fate passare le cordicelle attraverso l'occhiello. Passate il paracadute attraverso il cappio che si è formato e tirate in modo da stringere le cordicelle attorno all'occhiello.

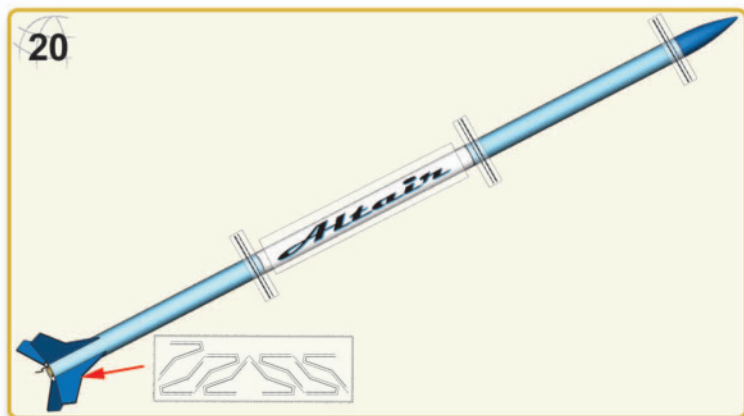

 Die Aufkleber gemäß Abbildung anbringen. Eventuelle Luftblasen von innen nach außen streichen.

 Apply stickers as shown on picture. Smooth out air bubbles from center to edge.

 Appliquer des autocollants comme indiqué sur la photo. Lisser les bulles d'air centre vers le bord.

 Aplicar pegatinas como se muestra en la foto. Suavice las burbujas de aire del centro al borde.

 Applicare le decal adesive come mostrato in figura. Eliminate le bolle d'aria premendo dal centro verso i bordi della decal.