



Versatile rocketry flight computer

Documentation and User Manual:

Module, Ground Station, and Software

Language: ENGLISH

Version 1.2 - 25 March 2024

Table of contents

0. INTRODUCTION

- 0.1 Introduction
- 0.2 Important notes
- 0.3 [Context and use cases](#)

1. FLUCTUS

- 1.1 Features
- 1.2 Installation and hardware details
- 1.3 [Power up, modes and interfaces](#)
- 1.4 Embedded software details
- 1.5 The BlackBox

2. STEADY

- 2.1 Introduction to the *Steady* ground station
- 2.2 Using *Steady*

3. FLUCTUS CONTROL CENTER

- 3.1 Fluctus Control Center, setup and updates
- 3.2 F.C.C. features
- 3.3 [Getting started](#)
- 3.4 Tab details
- 3.5 Fluctus Configuration
- 3.6 [The RuleSystem](#)
- 3.7 Downloading and opening BlackBox data
- 3.8 The BlackBox Viewer

4. USAGE

- 4.1 [Typical examples](#)
- 4.2 Frequently Asked Questions
- 4.3 Resources

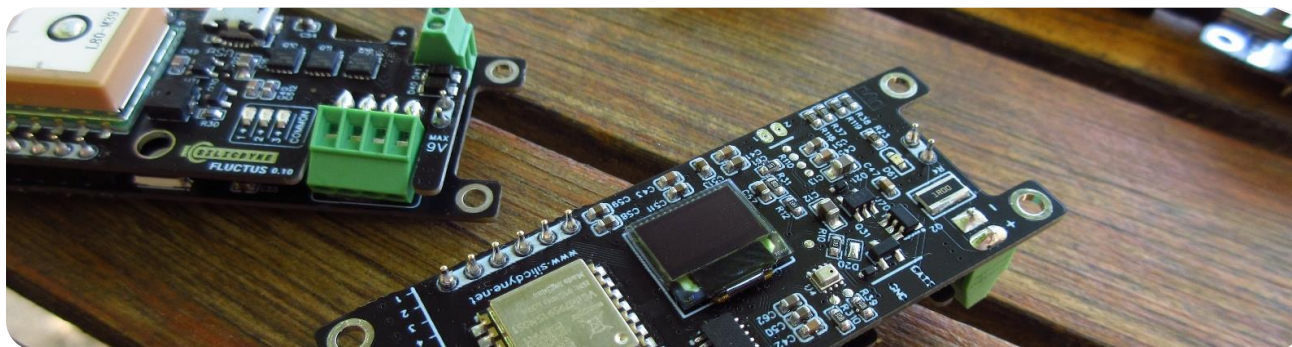

0.1 - Introduction

This document assumes that you already have a basic knowledge of electronics and rocketry. If you have any questions, please contact us by e-mail: contact@silicdyne.net

① Your question may have already been asked, so take a look at the [FAQ section](#)!

Fluctus is an advanced and versatile rocketry flight computer.

It combines the functions of high-end avionics systems: **flight recorder**, **deployment altimeter**, **telemeter** and **GPS tracker**, in a **single**, **compact** and **low-cost** module.

While it is highly flexible and can control complex rockets, it is also easy to use and has proved reliable, making it perfect for your next rocketry project.

This detailed documentation will guide you through all the features and specifications of the on-board flight computer “**Fluctus**”, the ground station “**Steady**” and the software “**FluctusControlCenter**”.

You will also find all the resources you need to implement the system in your own rocket.

0.2 - Important notes

- **Non-responsibility:**

We would like to point out that the use of this flight computer involves certain inherent risks. Although we have developed and tested our system rigorously to maximize its reliability, we can in no way be held responsible for any damage, accident or loss arising from a failure of the flight computer.

In other words: you assume full responsibility for any consequences arising from its use.

- **Warranty:**

We accept no liability for damage caused by improper use of the equipment. In case of damage, the user is fully responsible for all repair costs. Please care about the [precautions for use](#) !

- **Units:**

Software, hardware, and documentation are all based on international metric units.

0.3 - Context and use cases

Fluctus is an on-board flight computer, designed for use in your rocket.

It can be used to control **parachute ejection, engine ignition, flight data recording, GPS tracking**, and a lot of other advanced features. (see [section 1.1](#)). Furthermore, this flight computer is completely autonomous, requiring only a power source (typically a battery) to operate.

Thanks to its **rule chaining system**, Fluctus becomes very versatile and can be configured to execute a multitude of actions on actuators (pyrotechnics, servos, etc.), according to precise conditions and logics.

Fluctus communicates continuously with the “Steady” ground station, by radio.



This communication enables the module not only to send you telemetry data during the flight, but also to configure and control the flight computer remotely. The interface for this communication is the **FluctusControlCenter software** (abbreviated to F.C.C.), which can be installed on any Windows computer, and **linked to the Steady ground station** via USB.

Once the flight computer has been correctly configured, connected to the actuators, and powered up in your rocket, 2 major use cases available to you:

"Flight direct" mode enabled .	"Flight direct" mode disabled .
<p>This means that Fluctus is armed, ready to record data and waiting for launch as soon as it is powered up in your rocket - no action is required to enable it to operate. Thus, you don't need to bring your PC or ground station to the launch site.</p> <p>Fluctus detects that it is in your rocket when it is powered up and remains in flight orientation (vertical). (see section 1.4)</p>	<p>Fluctus is therefore in standby (IDLE) after power-up. You'll then be able to arm, start the black box, and the flight sequencer (possibly with a countdown timer) manually and remotely.</p> <p><i>Even if it's not the most convenient at first sight, not using the "Flight Direct" mode will give you more control and less doubt.</i></p>

After the flight, you will be able to download the black box data via the Fluctus USB port, and view/export them in the **F.C.C. BlackBox Viewer**.

1.1 - Features

WARNING: Software features are subject to change as updates are released.

- **Even enclosed in a rocket several hundred meters away, Fluctus remains fully connected.**
In fact, it is equipped with a high range radio transmitter and receiver.
Via the Steady ground station, connected to the **Fluctus Control Center** software on your computer, you can configure, control and monitor Fluctus in all circumstances. (see [section 2.1](#))
- **Simplified and reliable flight sequencer**, which is an integral part of the event management system. It incorporates a countdown timer, multiple air start capabilities and a multi-sensor fault-tolerant apogee detection. (Thus, there is no altitude limits!)
- **Compact on-board GPS.** The GPS receiver enables the module to know its 2D position instantly anywhere on Earth, up to **18km above sea level**.
- High-resolution **3-axis accelerometers**, over a range of **±200G**. Used for instant detection of launch, engine burnout, touchdown, and to estimate rocket speed in real time.
- **Gyrometer** enabling Fluctus to measure the rocket's angular speed and calculate its attitude (displacement angle from the launch axis).
Perfect for managing **propulsion stage separation in complete safety!**
- Factory-calibrated **atmospheric pressure sensor**, enabling Fluctus to determine rocket altitude quickly and accurately, up to **20,000m**.
A **velocity lockout** function enables the module to operate at speeds above Mach1, preventing the sequencer from being fooled by "supersonic bang" artifacts.

- **Black box data recording.** Triggered before the flight, the black box continuously records 40 samples per second of module data (altitude, acceleration, outputs status, GPS coordinates, and more...) for 15 minutes.
It also saves various flight and configuration information.
Data can then be downloaded via the USB port, analyzed, and exported using the BlackBox Viewer (see more in [section 3.7](#)).
- **3 pyrotechnic outputs,** with continuity detection and LED indicator. Connected to igniters via a screw terminal block, they provide a 10 Amps current output. These outputs are fully programmable.
- **4 digital outputs.** They can be programmed as ON/OFF, configured to drive servo motors, or even cameras.
2 analog inputs are also available for connecting additional analog sensors. (Example: pressure transducer, temperature sensor, contact sensor, etc.).
- Fluctus can operate with voltages ranging from **3.4 to 10 volts** and features a **reverse-polarity protection** circuit just behind the power connector, so there's no need to worry about the "magic smoke"!
The power stage also features a **voltmeter** for continuous monitoring of battery voltage.
- **On-board RGB LED and buzzer** for quick visual and audible feedback of the module status.
A **monochrome display** is soldered to the rear panel, making it easy to view miscellaneous information: no need to learn Morse code!
- **Advanced software features,** such as thrust characterization, dead reckoning, accelerometric apogee detection, RunCam™ remote control, and much more!
- **Flexible flight logic.** Fluctus manages flight events using the **RuleSystem**.
It consists of a chain of rules, each of which triggers various outputs or physical actions (pyrotechnics, servos...), by following threshold conditions on flight data (altitude, timer, apogee...)
This event system handles both simple and complex flights, with multiple parachutes, propulsion stages, payload ejection and more. **See [section 3.6](#)**

1.2 - Installation and hardware details

Fluctus is assembled as 2 boards, one on top of the other. It is easy to install in any bay with a free space of **12 by 3 cm by 2 cm in height**. Four M2 screw holes are located on each corner of the module, allowing it to be fixed to your bay.

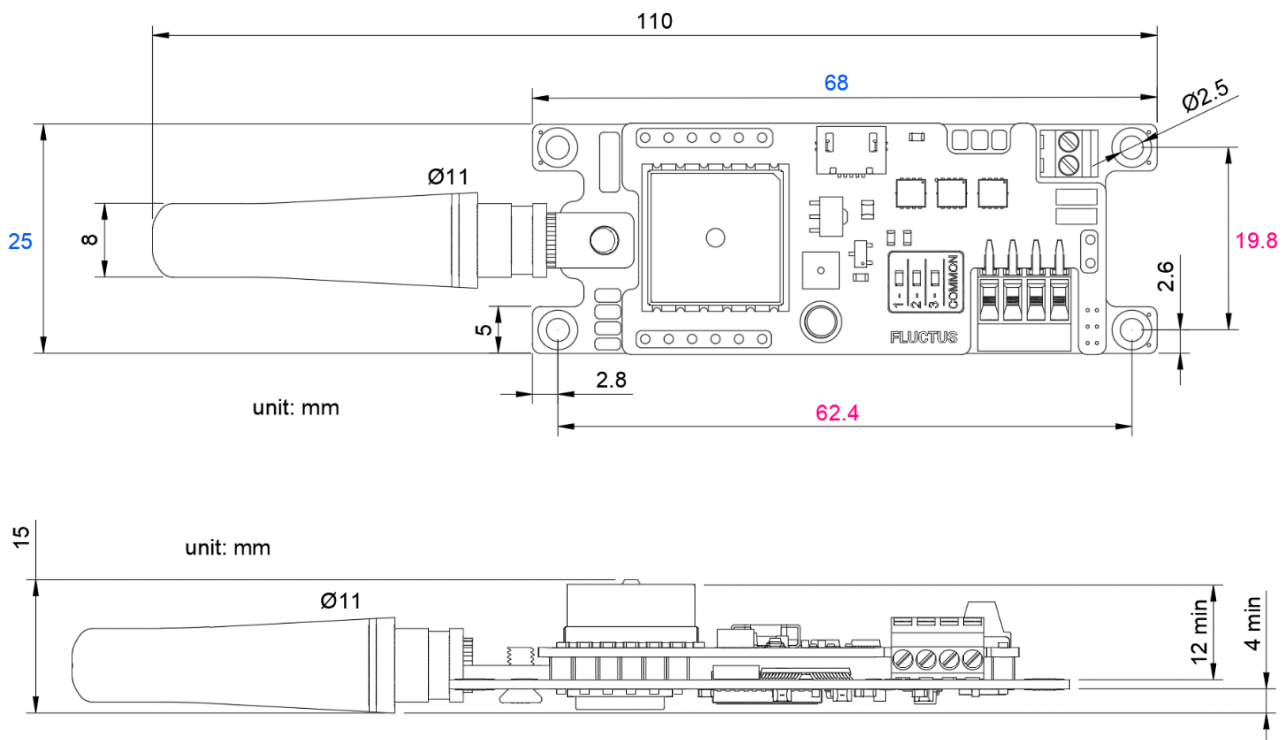

Recommendations for mounting the module can be found at the end of this section.

Fully assembled, **Fluctus weighs about 23 grams**.

FRONT FACE :

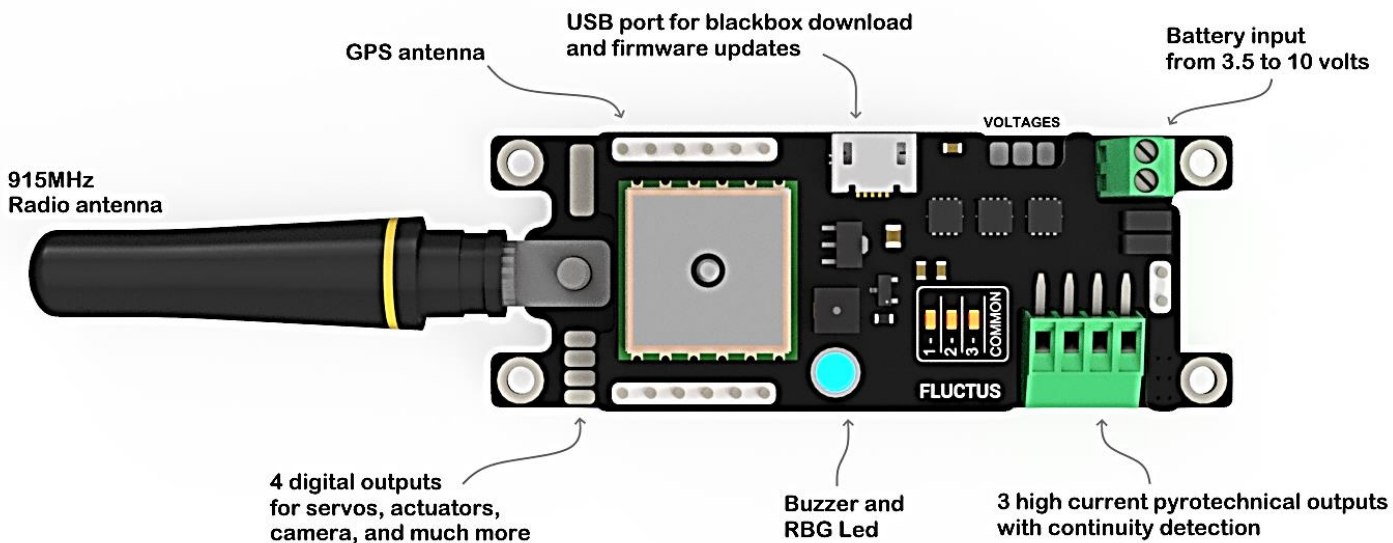

REAR FACE :

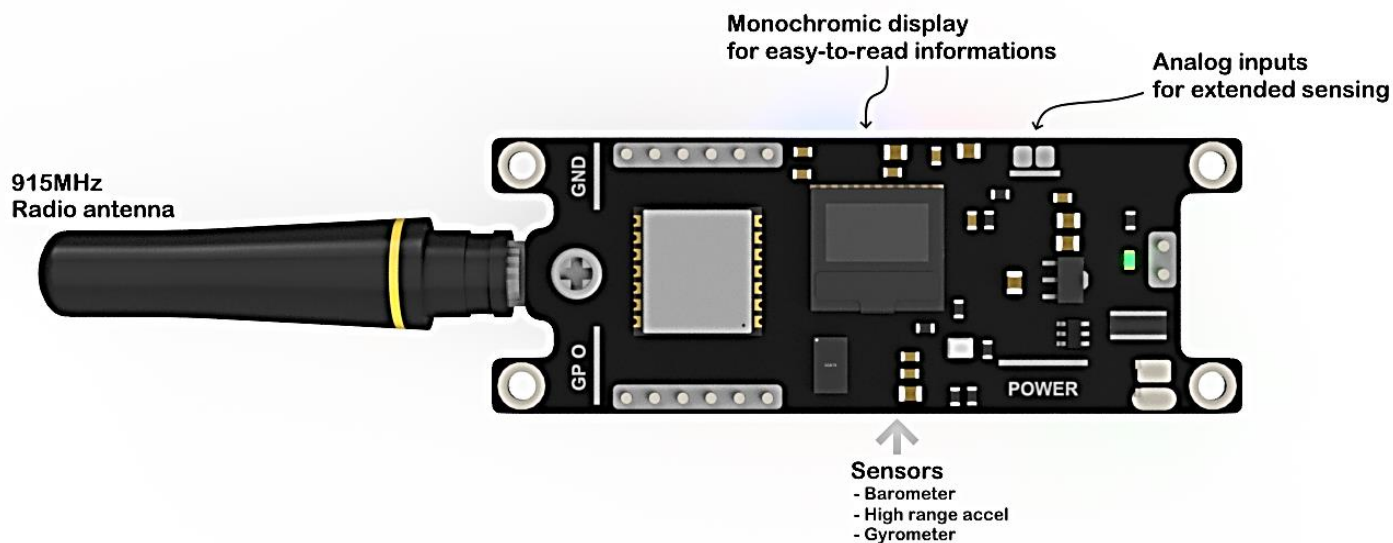

Components between the two boards:

- Microcontroller and dependencies
- Flash memory
- Gyrometer

Precautions for use:

WARNING: Please read the following carefully! No warranty claims will be accepted if the damage is caused by an operating error!

To preserve the integrity of the module, simple rules must be followed during use.

- The first thing, of course, is to [read this documentation carefully](#) to familiarize yourself with Fluctus before any operation.
- **NEVER START THE MODULE WITHOUT AN ANTENNA.**
Starting up the radio without an antenna will damage it and permanently impair performance. Use the supplied antenna or any other antenna with 50 ohms impedance and 915 Mhz band.
- **DO NOT PLACE THE MODULE ON ANYTHING METAL.**
All welds and components are exposed without insulation, and a short-circuit caused by contact between Fluctus and a metal part can cause irreversible damage.
- **Fluctus is sensitive to extreme humidity.**
This could lead to malfunctions, or even an inability to start the module properly. Also, rain or any conductive liquid can cause permanent damage.

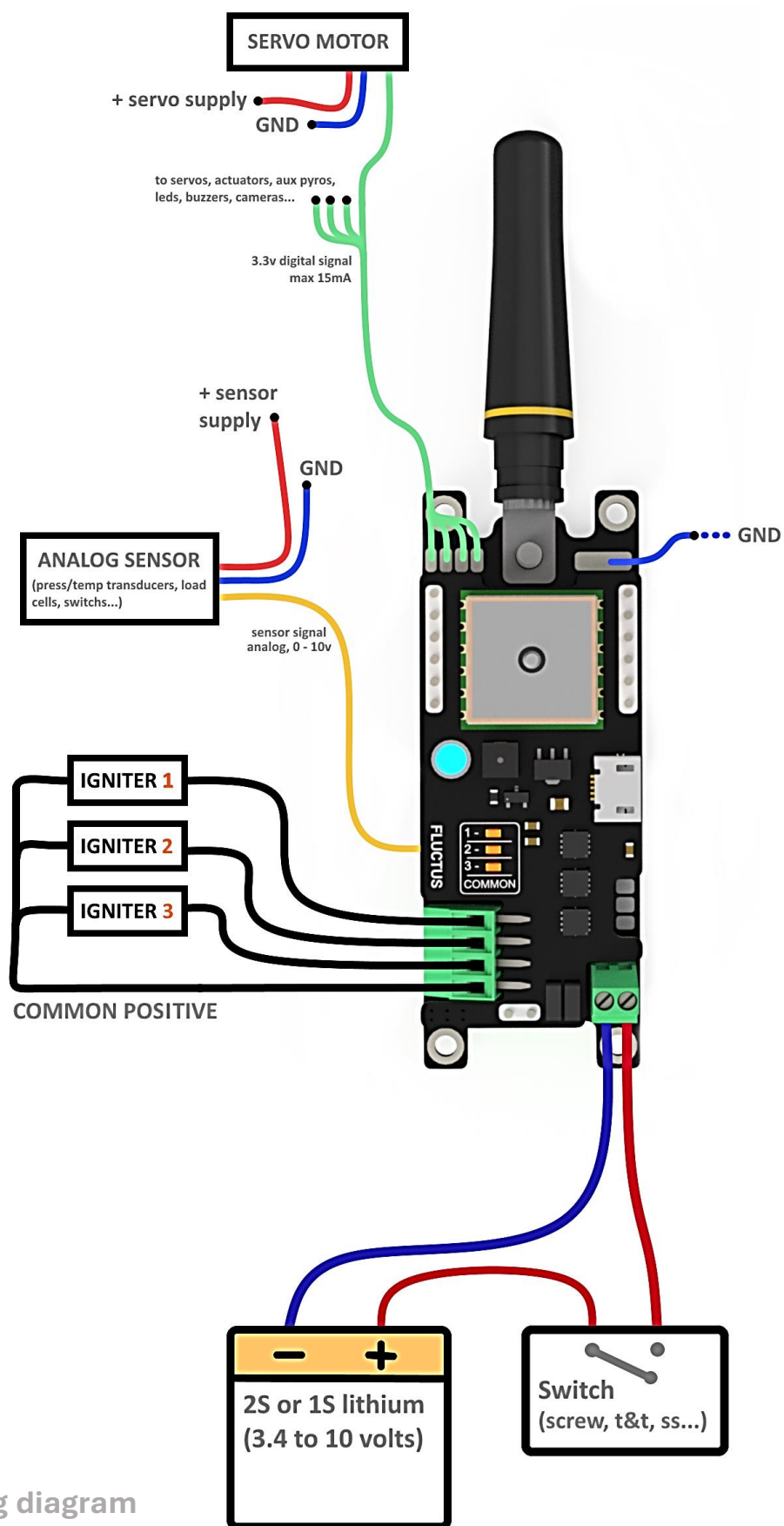

Fluctus
reference wiring diagram

Pyrotechnic outputs:

To trigger pyrotechnic igniters, Fluctus features 3 fully configurable high-power outputs. When one of these outputs is triggered, the battery is electrically connected to the associated connector.



The pyrotechnic connector is wired in the following order:

OUTPUT 1	OUTPUT 2	OUTPUT 3	COMMON POSITIVE
-----------------	-----------------	-----------------	------------------------

For each igniter, you will need to connect it between the output terminal you want to use, and the common positive terminal.

As the current of these outputs is not limited, please respect the current limit of 10A per output. The current that will be sent to the igniters can be easily calculated using the formula:

$$I = U / R$$

Where U is the battery voltage (Volt), R the igniter resistance (Ohm), and I the current that will be delivered (Ampere).

Each output channel is equipped with a continuity detection system to determine whether it is connected to a healthy pyrotechnic igniter by measuring its resistance. (test current: < 1mA)

Each output channel is equipped with a status LED. When lit, it means that the output is firing.

WARNING: For your own safety, do NOT connect an igniter until you are sure of what you are doing!

To power these outputs with a separate battery, you'll need to connect your igniters to the + of your battery (instead of the common terminal) and pool the - of your two batteries.

General Purpose auxiliary outputs:

Fluctus has a total of 4 "GP" (General Purpose) auxiliary outputs, enabling the module to be connected to auxiliary avionics systems and to drive servo motors.



These outputs emit 3.3 volts signals, which you can get between these 4 solder pads and the module's ground.

WARNING: These outputs are directly connected to the microcontroller and can be damaged if misused. They are reserved for signal generation only, not for power supply or anything else!

RunCam™ remote-control feature:

If you are using a RunCam™ camera on board your rocket, you may find it convenient to use the flight computer to remotely control its recording.

In fact, Fluctus can trigger RunCam’s video recording thanks to its UART communication port.

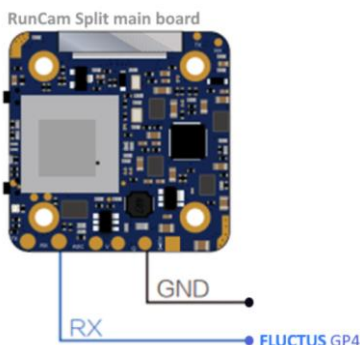

Therefore, to use this feature, you will need to connect the **GP4** auxiliary output of Fluctus (see previous part) to the **RX** input of the RunCam camera module.

Don't forget to common ground the two power sources if you are using separate batteries.

As soon as you have established this bridge, you will be able to control the RunCam remotely in the FluctusControlCenter, Realtime tab (see [section 3.4](#)).

Analog inputs:

2 analog inputs are available on the rear of the board, enabling Fluctus to sample the voltage from analog sensors (such as pressure transducers, temperature sensors, load cells, etc.).

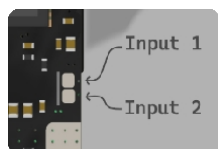

These 2 inputs are tin-plated pads. Thus, you will need to solder a cable to use them.

The voltage they read (from 0 to 10 volts maximum) is then placed in a variable which can be used by the RuleSystem and stored in the black box.

Connectors:

[Igniters and battery can be connected via screw connectors.](#) These types of screw terminal block allow rapid assembly/disassembly, as well as optimal contact and retention of the inserted cable. The terminal screws are M2 type (flat end).

For a clean installation, there are a few simple rules to follow:

- Use 20 to 13 AWG cables (approx. 1 to 2mm).
- Strip the cable to a length of about 3mm (to avoid short-circuits with adjacent terminals and reduce conductor fatigue as much as possible).
- Tighten the screw generously and take care not to insert too much sheath, as this could cause dummy contacts.
- Check that the conductor is held securely and does not "slip" out of the terminal block when pulled.

To use the auxiliary outputs and analog inputs, you'll need to solder a cable to the pads.

Radio and GPS:

[For optimum radio communication](#) (with the ground station) and GPS acquisition, please follow the recommendations below:

- Do not place the radio antenna parallel to a metal bar (threaded rod, electric cable, etc.) or near a large metal mass (battery, metallized bay, nut, etc.).
- Choose an airframe that is transparent to radio waves (plastic, phenolic, fiberglass and cardboard are much more transparent than carbon fiber or aluminum).
- If one of those recommendations cannot be followed, we recommend that you move the radio antenna to a more suitable location (by soldering a coaxial cable to the RF output).
- Avoid covering the GPS antenna as much as you can, and if possible avoid it facing a metal rail when the rocket is on the launch pad.

WARNING: The radio carrier frequency is on the ISM 915Mhz band, so you must obtain the necessary licenses to transmit!

NOTE FOR THE USA: Although not certified under *FCC Title 47 Part 15*, Fluctus, used for educational and experimental purposes in remote locations, is considered by the Federal Communications Commission to be "generally exempt" from authorization requirements. **Therefore, you don't need a license to use it on US territory.**

Battery:

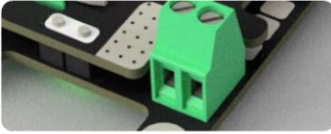

The battery that will power the entire module is connected through this screw connector.

The module's supply voltage can be between 3.4 and 10 volts. This voltage is constantly monitored by an on-board voltmeter and can be read remotely from the software (see [section 3.4](#)).

A reverse polarity protection circuit is installed on the power input to protect you in the event of a wiring error.

For the sake of reliability, we recommend that this voltage be supplied by a 2S lithium battery (7.4v nominal). Any power source will do, the key being that its voltage is within the module's operating range, **and that its discharge rate is sufficient** (see next).

Since both the logic and power sections are connected to the same power supply (by default), you need to ensure that [the battery can withstand the load of the pyrotechnic igniters](#). In other words, the battery must be able to deliver the current required to trigger an igniter (to calculate the current required, please refer to the previous part).

For lithium cells, the current that can be delivered by the battery is the multiplication of the capacity of the battery (in Ah) by the "discharge C" value indicated by the manufacturer.

WARNING: If the battery can only supply a current lower than that required by the igniter, the battery voltage will drop sharply during ignition. This can lead to serious electronic stability problems! (Called "brown-out").

If you use a separate battery for pyrotechnic outputs (see previous part), the risk of brown-out during ignition is eliminated (pyro voltage: 4 to 16 volts).

Fluctus consumes a maximum of around 400mW.

Autonomy can thus be calculated using the following formula:

$$t = Q / (0.400 / U)$$

Where Q is the battery capacity (Ah), U the battery voltage (volt), and t is the operating time (hour).

About sensors:

- **The barometric sensor for pressure measurement** is installed on the rear panel of the module (see location at the start of [section 1.2](#)). If liquid or anything else is inserted into the sensor hole, permanent damage can occur. The pressure sensor can also be damaged if there is excess pressure in your avionics bay (see [F.A.Q.](#)).
- There is no risk of damage to **the accelerometers** if the 200G operating range is exceeded (e.g. in the event of a shock). On the other hand, good calibration is necessary for optimum operation of the flight computer (see [section 1.3](#)).
- **The GPS receives its signals via the ceramic antenna on top of the flight computer.** It is recommended to keep this antenna facing the sky during satellite acquisition time. Satellite acquisition time varies according to weather conditions and the environment in which the module is placed (typically, reception is much weaker in a building than in the open air).
Under ideal conditions, acquisition time can be as little as 1 minute. Otherwise, it can extend to over 10 minutes. (Before complete satellite acquisition, no localization is possible). The GPS chip picks up several constellations, making it operational over virtually the entire surface of the Earth. There are bound to be several satellites available above your head!

Physical requirements to be considered when designing your bay:

- The space required BELOW the module must be at least 4mm.
- The module can be installed with the antenna up or down, **but its orientation must be specified in the configuration** (see [section 3.5](#)).
- Screw in the module (on the 4 holes provided) using M2 screws.
- It's not essential to have a view of the monochrome screen, which is merely a comfort feature.
- Access to the USB port is necessary for blackbox data download.
- The buzzer isn't very loud, so if you want to hear it, don't muffle it!
- Use thick (and if possible, multi-stranded) cables for connections to terminal blocks.
- **MAKE SURE THE BAY IS WELL VENTILATED!** Barometric data are crucial to Fluctus, so make sure your bay is well ventilated. Also, avoid high overpressure caused by an exploding charge, which could damage the barometer.
- **CAREFUL ANTENNA PLACEMENT!** Radio communications are highly sensitive to the environment. It is important to follow the above recommendations, otherwise communication quality can be considerably degraded.

Summary of physical properties:

PHYSICAL:

Weight	23.6 grams (including antenna)
Dimensions	109mm (68 without antenna) by 25mm by 13mm
Structure	2 PCBs on top of each other: PCB FR4 1mm
Mounting	4 holes 2.5mm for M2 screws in each corner
Needed space	A volume of 12 by 3 cm, by 2cm
Connectors	Battery and pyro: 2.54mm screw terminals, AUX outputs/inputs: 4mm pad

POWER:

Battery input	For LiPo 1S/2S and 9V, supports voltages from 3.4 to 10 volts
Consumption	Max. ~400mW (Excluding pyro ignition), see "Battery" part for more
Protections	Protected against reverse polarity
Regulations	DC-DC regulator 3.3 volts up to 500mA

INTERFACES:

Pyrotechnic outputs	3 outputs available with screw terminals and common positive Battery voltage, max 10A Continuity detection and LED status indication on each channel
Auxiliary outputs	4 digital outputs: binary or PWM servo control 3.3 volts, 200 ohms in series
Inputs	2 analog inputs (for events and logging), sampling from 0 to 10 volts
Human - Machine	High-power RGB LED Buzzer (can be set to different tones) 0.4" high contrast monochrome display
Radio	Screw-in antenna, 50Ω impedance LoRa 915Mhz modulation, max 22dBm (160mW) Half-duplex communication at 2hz (exchange of 2-4 packets per second)
Other	Micro USB connector for PC communication/power supply

SENSORS and OTHERS:

Pressure sensor	Samples pressure from 1200hPa to 300hPa (~9km) with 0.1m resolution. Extended pressure range down to 60hPa (~20km).
Temperature sensor	Measures ambient temperature with 0.1°C resolution
GPS	Multiple constellations captured by a high-gain patch ceramic antenna Estimates position to within ±3 meters, up to 18 km and 515 m/s
Accelerometers	Measures rocket accelerations on all 3 axes, over a range of ±200G
Gyrometer	Measures angular velocity on all 3 axes (±2000°/s)
Battery Voltmeter	Measures battery state-of-charge, 1mV resolution
Memory	Black box, configuration and calibration data on a 4MB FLASH memory chip. This memory is sufficient to record a flight of around 15 minutes.

1.3 - Power up, modes and interfaces

Power up:

The module is delivered ready to fly (or nearly so, excluding configuration).

To start it up, simply put the appropriate power supply to the connector (See more in [section 1.2](#), "battery").

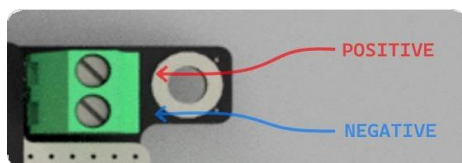

For simplicity's sake, we recommend that you take the first steps in the module by powering it via the USB connector. If an error occurs during start-up, please contact us and provide the error code obtained.

Code	Meaning
x1	INIT / RUNTIME : FLASH MEMORY
x2	INIT / RUNTIME : ACCELEROMETER
x3	INIT / RUNTIME : BAROMETER
x4	INIT / RUNTIME : GPS
x5	INIT / RUNTIME : GYROMETER

Accelerometers calibration:

For optimum operation of the Fluctus on-board software, the accelerometers needs to be calibrated. When Fluctus starts up for the first time, you will be asked to perform this calibration.

This phase will be indicated on the on-board display. To calibrate, you'll need a flat surface and make sure it's perfectly parallel to the horizon. Once you have this flat, level surface, you'll need to position the module on its bottom edge, the one opposite the USB connector.

After a short moment, the display will turn white and a series of beeps will sound for less than 5 seconds. **DURING THIS PHASE, KEEP THE MODULE ON ITS EDGE AND DO NOT MOVE IT!**

WARNING: Once calibration is complete, you can check it by observing the accel value in the real-time data stream. (See [section 3.4](#)). This should be as close as possible to 9.8 m/s^2 (the gravitational acceleration), regardless of module orientation. If this value is greater than 12, or less than 8 when the module remains static, calibration must be repeated.

To recalibrate, you need to reset Fluctus completely. This can be done using the "Reset config" button in the SETTINGS tab of Fluctus Control Center (see [section 3.4](#)). This action will also delete the stored configuration.

Modes and interfaces:

Fluctus can enter 3 different modes:

- **(START) →** On power up, the module starts with a **short start-up sequence** to initialize the entire system.

- The on-board display shows firmware version and accelerometer calibration progress (if necessary).
- The color of the RGB led will change to indicate:

Color	Meaning
Nothing or Red	An error has occurred
Purple	Long task in progress
Blue	Nothing to report, start-up
Orange	Accelerometer calibration
Green	Ready, switching to IDLE

- The buzzer will beep to indicate:

Sound	Meaning
High-pitched beep	Long task in progress
Short medio beep	Start
Short low beep	Accelerometer calibration
Crescendo	Ready, switching to IDLE
“Beep Bop Beep Bop...”	An error has occurred

- **IDLE →** After start-up, **the module will enter this mode directly. It is then possible to configure, test and control the module.** This is also the mode where you can start the flight sequencer, and thus switch to FLIGHT mode.

Fluctus will remain in this mode for less than 4 seconds if the "Flight Direct" option is enabled and the conditions are met!

- The on-board display will show useful information about status, configuration and Fluctus sensors.
- The color of the RGB led will remain white by default, but color flashes will indicate:

Color	Meaning
White (animated)	Nothing to report
Purple	Long task in progress
Blue flash	Radio packet received

- The buzzer will beep to indicate:

Sound	Meaning
High-pitched beep	Long task in progress
Short high-pitched beep	Radio packet received

- **FLIGHT** → After arming, this mode can be accessed by triggering the flight sequencer. It can also be accessed on power-up, if the "Flight Direct" option is enabled and conditions are met (see [section 0.3](#) for more details).

This is the mode in which the entire flight will take place, and can only be exited by power off. Beside flight sequencer handling and flight rules, nothing changes: you can perform any action in either IDLE or FLIGHT mode.

Barometric altitude, accelerometer and gyrometer will be recalibrated to 0 on entry.

As soon as the module enters this mode, the sequencer clock starts.

From T - {countdown value}, if configured.

- o The on-board display will show information about the flight sequencer.
- o The RGB led will take on different colors depending on the phase of flight, and color flashes will indicate:

Color	Meaning
Purple	Long task in progress
Blue flash	Radio packet received
Turquoise (animated)	Countdown started
Red (animated)	Waiting for launch
Blue (animated)	Ascent phase
Purple (animated)	Descent phase
Green (animated)	Touchdown

- o The buzzer will beep to indicate these actions:

Sound	Action
+ SAME SOUNDS AS IN IDLE MODE	
Moderate beep beep (2 per sec)	Ready and waiting for launch...
Long low beep	Apogee detected
Short high-pitched beep	Launch / Airstart detected
Short low-pitched beep	Burnout detected

- **UPLOAD** → The module will go into UPLOAD mode when transferring data from the black box via USB. The system is therefore completely locked but will restart automatically once the transfer carried out.

- o The on-board display will show information about the transfer.
- o The color of the RGB LED will change to indicate:

Color	Meaning
Purple	Long task in progress
Flashing green	Ready to upload
Yellow	Packet transfer in progress

- o The buzzer will remain permanently silent.

The Fluctus monochrome display shows the most helpful information, making it much more convenient and less frustrating to use.

Here are the different displays you may come across.

START



Starting Fluctus
(firmware version)



Calibration of the
accelerometer

IDLE

In IDLE mode, an info bar is displayed at the top of the screen. This indicates (by highlighting) the status of the black box, the arming status, the GPS status, and the radio channel in use.



For example, in this case: the black box is disabled, the module is armed, the GPS is not ready, and the radio is on channel F (Foxtrot).

To navigate between the 4 panels below, gently shake the flight computer once.



Altitude
Acceleration glb
Speed vert.



GPS lock status
Amount of sats
GPS time (UTC)



Battery voltage
Pyro continuity
Free space BBox

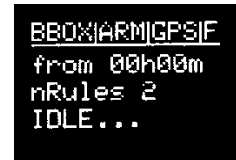

Config time
Rules count

FLIGHT



Sequencer status
Altitude

UPLOAD

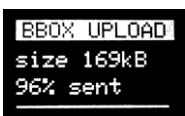

Black box file size
Transfer progress (size sent)

1.4 - Embedded software details

The status of the flight sequencer is represented by a number. This number, ranging from 0 to 6, is indicated by the "status" variable. Here's what it means:

0	IDLE	Fluctus is in IDLE mode.
1	ARMED	Fluctus is in IDLE mode and armed.
2	COUNTDOWN ENGAGED	The flight sequencer is enabled, Fluctus is in FLIGHT mode (and the countdown timer is running if configured).
3	WAITING FOR LAUNCH	The countdown is over, Fluctus is ready for launch. Waiting for launch detection...
4	ASCENT	Launch is detected, the rocket climbs to its apogee.
5	DESCENT	The apogee has been reached; the rocket is on its way down.
6	TOUCHDOWN	Fluctus has detected the rocket's touchdown. The flight is over.

The status of each pyrotechnic output is represented by a number. This will enable you to determine the state of continuity and activation of the output. Here are its meanings:

0	DISABLED	Output disabled; no continuity detected.
10	ENABLED	Output is enabled (fire).
1	CONTINUITY	The output is disabled and detects continuity.

WARNING: Detection and calculation algorithms are subject to change and refinement (thanks to your help, among others).

Altitude is calculated by:

- Nasa GRC's atmosphere pressure model, using IIR filtered barometer pressure data
- Dead Reckoning: 2 Integration of accelerometers and gyrometer data

The flight computer automatically switches between the more relevant of these two values.

Vertical speed is calculated by:

- Dead Reckoning: Integration of accelerometers and gyrometer data
- Low pass filtering of barometric altitude derivative

The flight computer automatically switches between the more relevant of these two values.

Global acceleration is calculated by applying the Pythagorean theorem to the X, Y and Z axes. This value is therefore always positive and considers the acceleration of gravity: when the flight computer is static, on Earth, whatever its orientation, the global acceleration should be around 9.81 m/s^2 (= 1G).

[Launch detection works as follows:](#)

- If global acceleration exceeds 30m/s^2 over a series of 2 readings, launch is detected.
- If the first detection fails, the launch will be detected when the rocket rises above 50 meters.
- The sequencer switches to "ASCENT", the RuleSystem "Launch detected" event is triggered.
- Note: max reactivity 100ms

[Motor burnout detection works as follows:](#)

- If the rocket's speed (dedrck) decreases over a series of 2 readings, a burnout is detected. Other burnouts can be detected after an airstart.
- The RuleSystem "Burnout" event is triggered.
- Note: max reactivity 100ms, detection lockout below 5m (dedrck)

[Airstart detection works as follows:](#)

- If vertical acceleration exceeds 20m/s^2 over a series of 2 readings, an airstart is detected.
- The RuleSystem "Launch detected" event is triggered.
- Note: max reactivity 100ms, airstart detection lockout below 10m/s (dedrck)

[Touchdown detection works as follows:](#)

- If the global acceleration remains below 12m/s^2 ($\sim 1\text{G}$) and the raw barometric speed remains within $\pm 3\text{m/s}$, for 500 milliseconds, touchdown is detected. **Flight is over.**
- Sequencer switches to "TOUCHDOWN", RuleSystem "Touchdown" event is triggered.
- Note: max reactivity 550ms

[Apogee detection works as follows:](#)

- If motor burnout has been detected and vertical speed (barometric) remains below 0m/s for more than 500ms, apogee is detected.
- **Vel. lock feature inhibits apogee detection when rocket speed (dedrck) exceeds 20m/s.**
- The sequencer switches to "DESCENT", the RuleSystem "Apogee" event is triggered.
- "Multi-sensor fault-tolerant":
 - o If the barometer is detected as faulty, or out of its operating range ($\sim 20\text{km}$ altitude, 60hPa), then apogee will be detected by speed (dedrck) and therefore by the accelerometer (**thus, no altitude limit**)
- Note: max reactivity 1000ms, detection lockout below 20m

["Flight direct" option's ready for launch detection works as follows:](#)

- If Fluctus is powered by the battery (not by USB), mounted vertically (according to its orientation configuration) and don't move, it will start a 5 second countdown for launch readiness.
- If Fluctus moves by more than 5° during this countdown, launch readiness is aborted.

1.5 - The BlackBox

During the flight, Fluctus will record a large amount of data about the sensors, status, and internal calculations: [it's the BlackBox](#).

These important (and non-volatile) data, stored in the flash memory, can be **downloaded via the USB port any time after the flight**.

The black box has an “auto stop” option that can be enabled during configuration. This option will automatically stop the black box 30 seconds after touchdown. (Recommended)

Regardless anything, the black box will automatically record flight data at launch, without the need to worry about anything concerning it beforehand.

Regardless anything, it incorporates a circular buffer to record the last second before launch is detected (i.e. data is recorded from T-1s). This means that **no data** will be saved before T-1s! (Unless you start the black box manually beforehand in F.C.C.)

WARNING: Old flight data will be automatically deleted when the black box starts!
There's room for only one flight!

Approximately **15 minutes of flight time** can be stored in the memory.

Data is stored in block form, and each block contains a table of the entire data set. The black box system records a block, called a "frame", at each tick (40hz). [In other words, each recorded value is recorded 40 times per second](#).

[Fluctus can record "Flags" in the black box](#). These are independent markers, which can be written on certain flight events, or simply to mark an info item or an error. To keep track of your flight rules, you can have them write a Flag when they are triggered.

A termination flag will be written at the end of the blackbox data, indicating why it stopped and whether it was intentional or not.

List of all data recorded at each frame:

time	Frame time (milliseconds)	analog2	Analog input voltage 1 (mV)
deltaTime	Time since last tick (ms)	analog1	Analog input voltage 2 (mV)
status	Flight sequencer status	inFreefall	Rocket in free fall (bool)
baro-altitude	Baro altitude from origin (m)	gpsLat	GPS latitude
dedrck-v-speed	Deadreck verti. speed (m/s)	gpsLng	GPS longitude
angle	Angle of displacement (°)	gpsState	GPS status
roll-rate	Roll rate (°/s)	gpsSats	Number of GPS satellites
vert-accel	Vertical acceleration (m/s ²)		
accel	Global acceleration (m/s ²)		
dedrck-alti	Altitude, dead reckoning (m)		
baro-speed	Barometric vertical speed		
amb-temp	Ambient temperature (°c)		
batt-voltage	Battery voltage (mV)		
P1-state	Pyrotechnic output 1 status		
P2-state	Pyrotechnic output 2 status		
P3-state	Pyrotechnic output 3 status		

In addition to the frames, the black box also records the following data:

- Fluctus firmware version
- Date and time (UTC) of the flight
- Frame values index
- Fluctus configuration
- Flight rules



The flash memory chip is placed between the two boards just below the antenna. This placement is ideal, as it provides maximum protection for the chip in the event of an extremely violent crash.

This chip contains all the black box data. If, after a crash, the flight computer is made unusable and is unable to communicate with a PC for data download, it may be possible to recover the contents of this memory.

To obtain these recovery tools, contact us!

2.1 - Introduction to the *Steady* ground station

Steady is the main tool for communicating with *Fluctus*: it's a ground station that will enable the flight computer to be controlled remotely, from a PC, through radio waves.

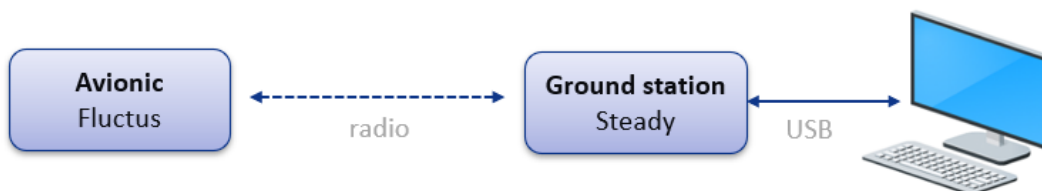

This ground station takes the form of a large antenna, capable of both receiving data and outputting it to a USB port, as well as receiving data on the same port and sending it by radio to the flight computer (on the same channel).

Using the **Fluctus Control Center** software you can view telemetry, send commands, and configure *Fluctus*, through the ground station.

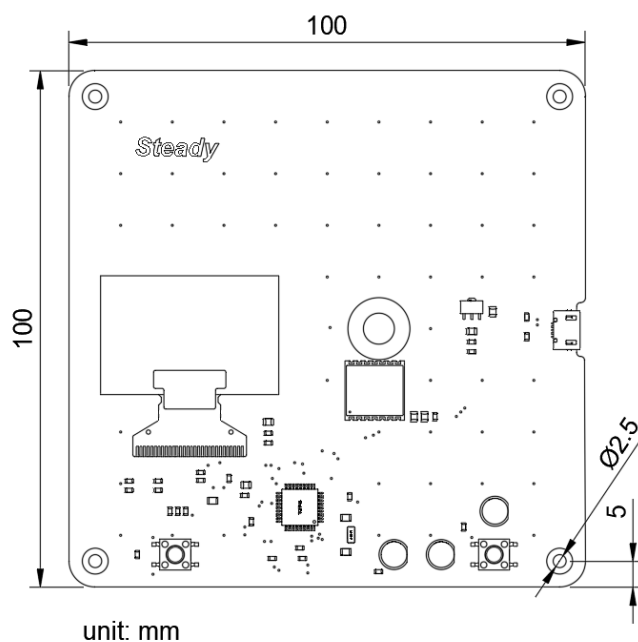

Steady is made up of a 10 x 10 cm central board, placed on 4 anti-slips.

This board features a standard SMA connector for a large 21cm omnidirectional radio antenna.

There's also a micro-USB connector, a 1.3-inch monochrome display, 2 buttons and 3 status LEDs.

2.2 - Using Steady

Here's the 5 key points to know to understand how the ground station works:

- To use several modules at the same time, the communication system has 26 independent channels (Alpha, Bravo, Charlie.... Zulu) that you can select.
- When Steady is powered up, it goes into a waiting state, and will automatically come out of it when you connect it to the F.C.C. software.
- When a communication has been started and no packet has been received for 5 seconds, the connection status goes to "timeout".
- The Steady ground station is equipped with several interfaces for intuitive monitoring and interaction with the hardware.
- The Steady ground station incorporates a packet verification system, known as "checksum", to identify packets whose content has been changed during transmission. Packets failing this test will not be processed by F.C.C.

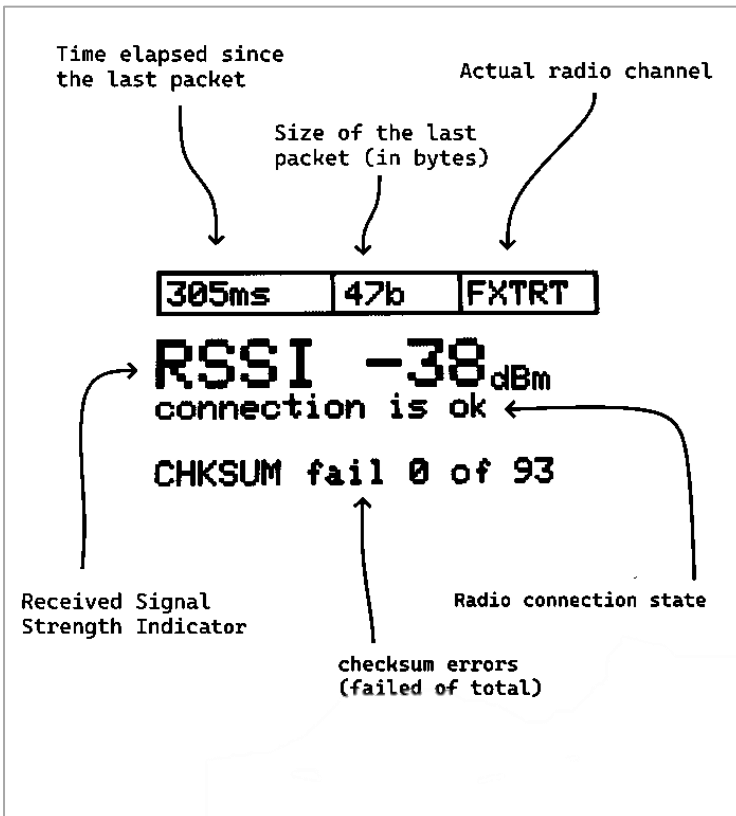

Useful information about radio communication is displayed on the monochrome screen, such as:

- Packet information: time since receipt, length, and signal strength.
- Information about the station itself, such as timeout status, proportion of valid packets received, and currently active channel.

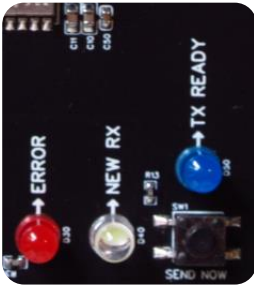

Meaning of the 3 status LEDs:

White : NEW RX	Short flash when a new packet is received by radio
Red : ERROR	Flashes when no connection is established and lights up when the connection goes into timeout. Flashes when the received packet is detected as wrong
Blue : TX READY	Lights up when a packet is ready to be sent by radio

When a packet is ready to be sent by radio, it is placed on hold (indicated by the blue LED) and will be sent as soon as the next one is received. This avoids any risk of radio "collision" and guarantees optimal communication.

On the other hand, if for any reason downlink communication between the module and the ground station is interrupted, it is still possible to transmit a packet by radio (although there is no guarantee that it will be correctly received). [Simply press the "SEND NOW" button below the blue LED.](#)

By holding down the "MAIN" button, a secondary panel is displayed, showing various additional communication information.

[The communication system, as explained above, manages 26 independent channels.](#) It operates using LoRa 915Mhz modulation, exchanging data at a speed of 390 bytes/second, on a 125khz radio bandwidth.

The frequency (in MHz) of a channel (from 0 to 25) is given by the following formula:

$$Frequency = 911.75 + (channel * 0.25)$$

On the selected channel, the ground station identify packets coming from Fluctus by detecting its "call sign".

The RSSI, which stands for Received Signal Strength Indicator, is a numerical value that represents the received signal strength, in dBm (decibel-milliwatt).

[The higher this value, the stronger the signal received.](#)

3.1 - Fluctus Control Center, setup and updates

Fluctus Control Center (abbreviated F.C.C.) is a PC software that lets you perform all control and configuration functions on the Fluctus module, remotely via the Steady ground station. It's the "Live" interface.

Fluctus Control Center also lets you download, analyze and export black box flight data. It's the "BlackBox Viewer" interface.

Setup and updates:

For compatibility reasons, **F.C.C. and Fluctus** software versions **must be identical**.

WARNING: You must carry out the requested updates. Otherwise, radio communication will be refused.

The F.C.C. version identifier is visible at startup, bottom left.

The Fluctus version identifier is visible on the display for a few seconds after power-up.

In the event of an important radio-related update, you may need to update the Steady ground station firmware: follow the same procedure.

To update F.C.C., download the latest portable version from silicdyne.net. The latest compatible update files are directly contained in the software.

To update a firmware, follow this procedure:

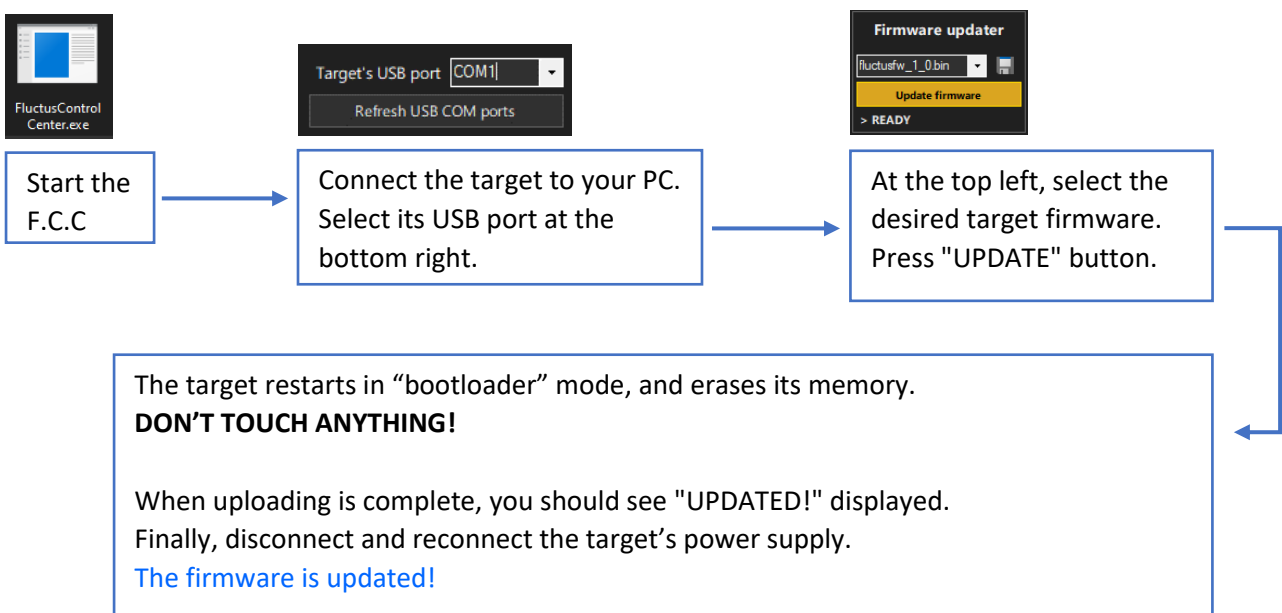

3.2 - F.C.C. features

LIVE interface:

- Easy access to essential telemetry information.
- Voice synthesizer, allowing you to follow the flight without having to look at the screen.
- Remote arming and controls, as well as a useful “Ready in one click” button.
- Read and send configuration remotely, with the RuleSystem editor and integrated flight logic examples.
- Firing and continuity of pyrotechnic outputs.
- GPS data displayed on a map in real time, and automatic QR code generation for instant retrieval of the rocket's location on your smartphone.
- Real-time plots for any data received.
- Sending and adding RuleSystem commands.
- RunCam™ remote-control feature.
- Ground station radio packets logging.

BLACKBOX VIEWER interface:

- Generation of a flight summary containing key flight data.
- Automatic generation of graphs to visualize data over time.
- Timeline for easy navigation to specific events in the file.
- Visualization of the rocket's trajectory on a 3D map.
- Motor thrust and vehicle aerodynamic characterization tools.
- Export the black box to a .csv file for further analysis, processing, and calculation in a spreadsheet program.
- Display and export the Fluctus configuration used.
- List of flight Flags.

OTHERS:

- Embedded firmware updater.
- BlackBox flight data downloader.
- Fluctus USB Tools for debugging and testing purposes.

3.3 - Getting started

AFTER HAVING CAREFULLY READ ALL THE HARDWARE AND SOFTWARE DOCUMENTATION IN THE SECTIONS ABOVE, you can start using Fluctus!

- To begin, power up the module as described in [section 1.3](#). Keep it powered up for the rest of the procedure.
- Start Fluctus Control Center, make sure you have the latest firmware and F.C.C. version. (See more in [section 3.1](#)).
- **Screw the ground station's radio antenna**, and then connect it to your PC via its USB connector.
- Once Steady has started up, the words "Awaiting USB" should appear on its screen.
- In the bottom right-hand corner, refresh the list of USB devices, then select the one to which Steady is connected. If you encounter difficulties, take a look at the [FAQ section](#).
- In the connection box, select the radio channel on which Fluctus transmits and listens. This is visible on the display (see [section 1.3](#)).
- Click on "Connect to Steady G.S." and wait a few seconds, the Live interface should open. [The connection to the station is established!](#)

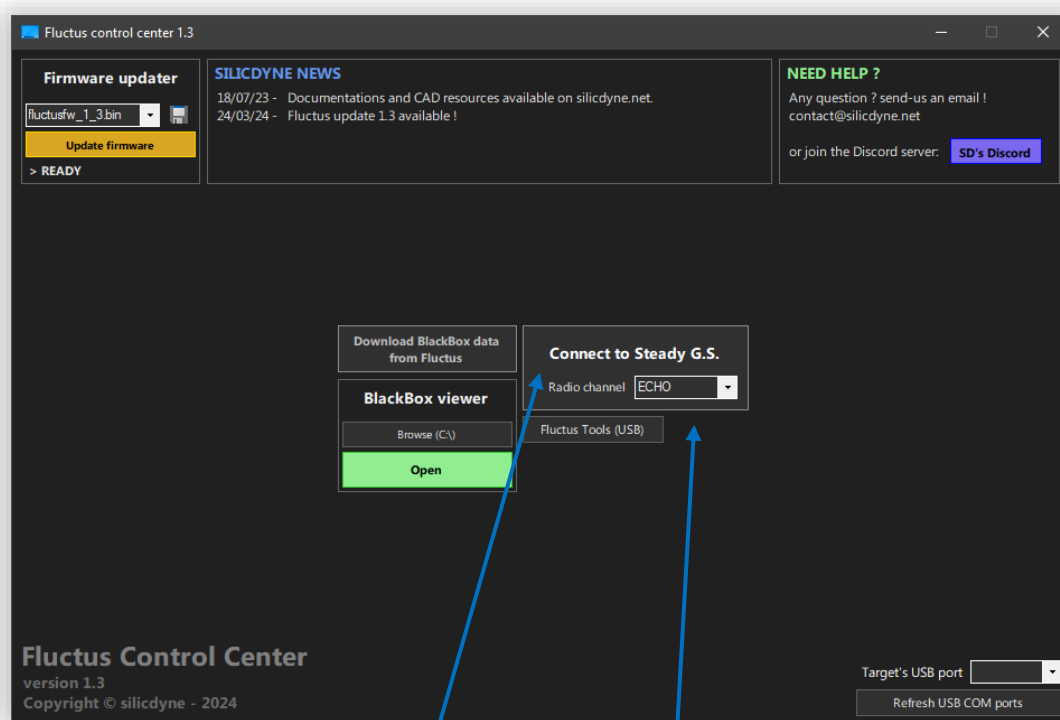

Connection to the station

Radio channel on which Fluctus is configured

Selection of the ground station's USB COM port

You're now on the Live interface, more precisely on the Overview tab.

Steady's white LED should start flashing, indicating that it is receiving the packets transmitted by Fluctus on the radio channel **2 times per second**.

These packets are processed almost instantaneously by Fluctus Control Center.

Interface header:

This header is common to the entire Live interface. It includes buttons for navigating between tabs, and indicators about Fluctus and radio communication.

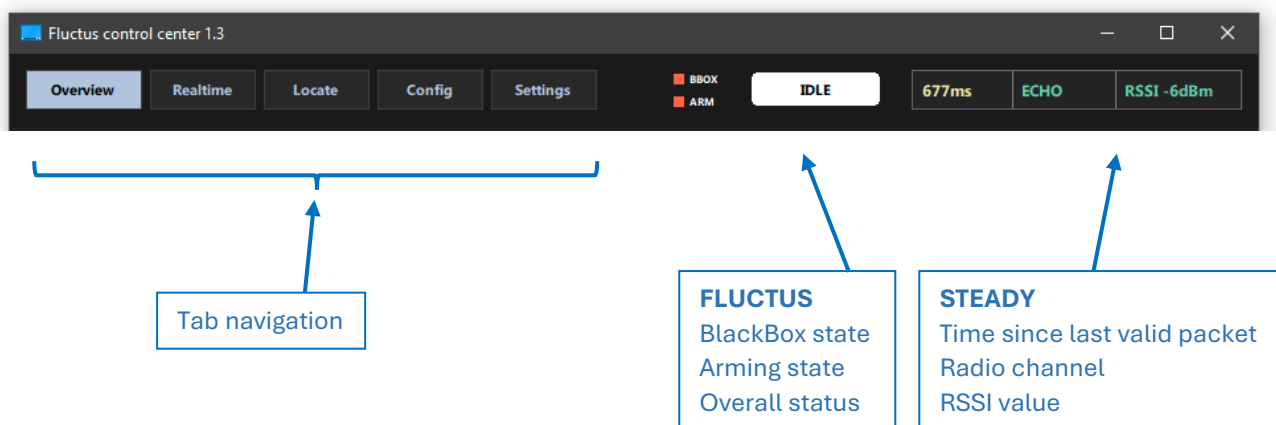

3.4 - Tab details

OVERVIEW

The **Overview** tab is the first thing you'll see when you connect.

You'll find all the basic telemetry data, a summary of the status of the module, and basic commands (manual arming and black box activation, and **“Ready in one click”** button). There's also a diagram showing the timeline of the flight sequencer.

The screenshot shows the 'Fluctus control center 1.3' interface. At the top, there are navigation tabs: Overview (selected), Realtime, Locate, Config, and Settings. On the right, there are status indicators: SBOX (red), ARM (red), IDLE (white), 613ms, ECHO (green), and RSSI -9dBm. Below this is a flight sequencer timeline with stages: Countdown (T 0.0), CtDw + Wait (0.0s), Launch detected (T 0.0), ASCENT (0.0s), Apogee (T 0.0), DESCENT (0.0s), and Touchdown (T 0.0). To the right of the timeline is a large 'T 0.0 idle...' display. The main area is divided into several sections: a central 'FLIGHT DATA' section showing 0.1 m altitude from origin, 0.0 m/s vertical speed, and 1.0 G global acceleration; a 'battery voltage' section showing 3.82 V; a 'gps status' section showing NO FIX; and a 'COMMANDS' section with a 'JUST ARM' button. Below the commands is a 'RULESYSTEM COMMANDS' section with a 'ARM, START BLACKBOX AND START FLIGHT SEQUENCER' button. Callouts point to these sections: 'Real-time sequencer timeline' points to the flight sequencer timeline; 'Sequencer time and status (Fluctus mode)' points to the 'T 0.0 idle...' display; 'FLIGHT DATA' points to the central telemetry section; 'COMMANDS' points to the 'JUST ARM' button; and 'RULESYSTEM COMMANDS' points to the 'ARM, START BLACKBOX AND START FLIGHT SEQUENCER' button.

Real-time sequencer timeline

Sequencer time and status (Fluctus mode)

FLIGHT DATA
 Vertical altitude (from origin)
 Vertical speed (relative origin)
 Global acceleration
 Battery voltage
 Rocket displacement angle visualizer

COMMANDS
 Ready in one click button
 BlackBox manual start
 Manual arming

RULESYSTEM COMMANDS
 used to trigger your own custom events during the flight.

REALTIME

The **Realtime** tab embeds several communication features with Fluctus.

Here, it's possible to configure a graph that automatically plots the evolution of a value over time. This is also where you can send (and create) your commands to the Fluctus RuleSystem (see more in [section 3.6](#)), and where the RunCam™ remote-control feature is accessible.

Finally, the Realtime tab also gives you access to pyrotechnic outputs fire button (when the module is armed) and their state of continuity.

The screenshot shows the 'Fluctus control center 1.3' interface. At the top, there are tabs for Overview, Realtime (selected), Locate, Config, and Settings. On the right, there are status indicators for BBOX, ARM, TOUCHDOWN, 622ms, ECHO, and RSSI -23dBm. The main area features a line graph with a y-axis ranging from -1.9 to 36.8 and an x-axis from -60 to 0. A sharp peak is visible at approximately x=-35. Below the graph, there is a dropdown menu for 'altitude' showing 'Value: -0.3 at 187.6s' and 'Min to max: -0.9, 35.8'. At the bottom left, there is a 'Test command 1' section with a 'NAME:' field and an 'ADD COMMAND' button. At the bottom right, there is a 'Pyro outputs' table and a 'Runcam™ command on GP pin 4' section with 'START recording' and 'STOP recording' buttons. A 'show radio packet content' link is at the bottom left.

Graph to visualize the evolution of a value over time

RunCam™ command buttons

Adding and triggering of RuleSystem commands

Continuity of pyrotechnic outputs and firing (requires arming)

Name	Continuity	Triggering
Pyro1	Disconnected	FIRE.
Pyro2	Disconnected	FIRE.
Pyro3	Disconnected	FIRE.

LOCATE

The **Locate** tab lets you instantly retrieve and use data from the GPS system on board Fluctus.

In fact, you'll find a 2D map showing the precise location of the rocket. To check the quality of the signal, the number of satellites acquired is displayed.

A QRCode will be generated automatically each time new GPS data is acquired. This QRCode is very convenient, as once scanned by your smartphone, **it will automatically redirect you to Google Maps and guide you to the rocket's coordinates.**

The screenshot shows the 'Locate' tab in the 'Fluctus control center 1.3' interface. The interface includes a navigation menu with 'Overview', 'Realtime', 'Locate', 'Config', and 'Settings'. The 'Locate' tab is active, displaying the following information:

- GPS location:** alt: 1360.0, lat: 37.223800, lng: -115.795400
- GPS state:** status: ready for 3D pos, satellites fixed: 12
- System status:** BBOX (red), ARM (orange), IDLE (white), 699ms (green), ECHO (green), RSSI -17dBm (green)
- Map:** A satellite map showing the rocket's location with a red pin. The zoom level is set to 10, and there is a 'Refresh map' button.
- QR Code:** A large QR code is displayed, which links to Google Maps at the rocket's coordinates.

Callout boxes provide additional context:

- 'GPS signal status and amount of satellites' points to the 'satellites fixed: 12' field.
- 'GPS coordinates and estimated altitude' points to the 'GPS location' data.
- 'Satellite map of then environment with the location of Fluctus' points to the satellite map.
- 'Zoom level and map refresh' points to the zoom slider and 'Refresh map' button.
- 'Google Maps QRCode to the coordinates' points to the QR code.

SETTINGS

The **Settings** tab gives you access to Steady and Fluctus system commands.

FLUCTUS SYSTEM COMMANDS (radio)

Command	Usage
Radio Ping test	Allows you to radio a "ping" to Fluctus. If Fluctus receives it, it will send back a "pong" which will be indicated to you: very useful for testing the reliability of the radio communication!
Erase black-box	Deletes black-box data from flash memory
Reset config	Resets the configuration part of the flash memory (including calibration data!)
Reboot Fluctus	Restarts Fluctus remotely

STEADY SYSTEM COMMANDS

Command	Usage

F.C.C. parameters

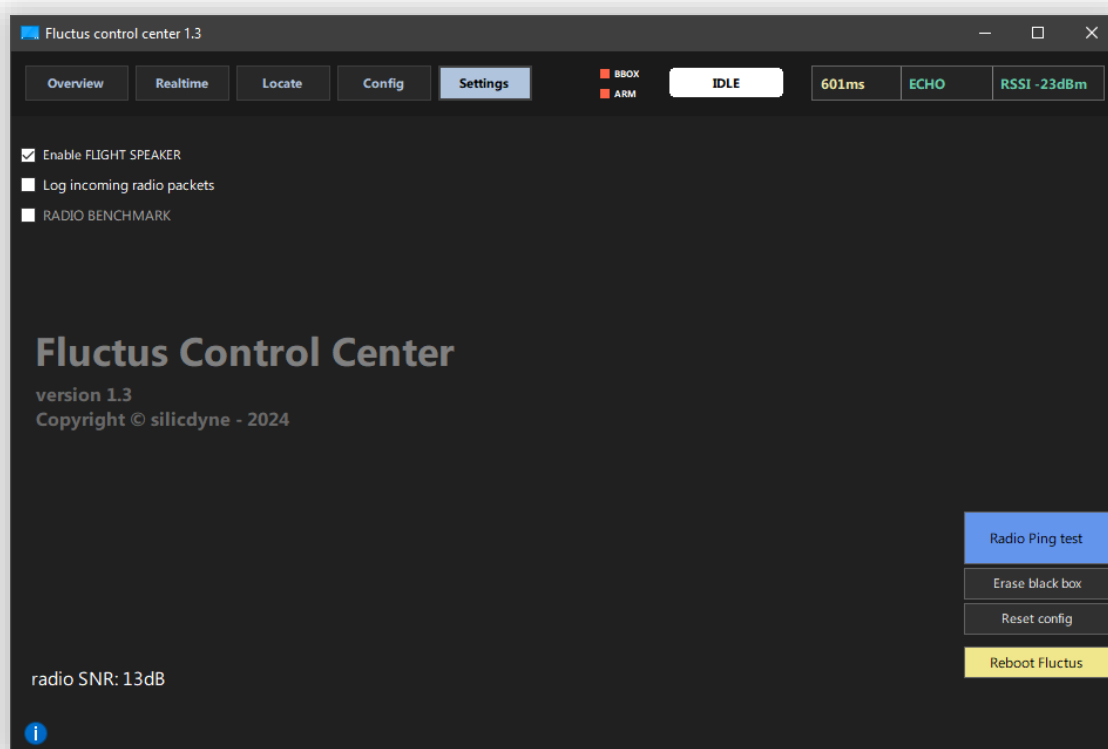

System commands to Fluctus (by radio)

CONFIG

The **Config** tab enables you to configure various parameters, as well as adding the flight rules that will describe all your rocket's events.

Once the configuration is complete, **you need to write it to Fluctus**, remotely, via the ground station. You can also read the current configuration and manage different profiles.

More information in [section 3.5](#) and [3.6](#).

The screenshot shows the 'Config' tab of the Fluctus control center. It features a 'RuleSystem configurator' on the left with two rule entries: 'when Apogee' and 'during Descent'. Each rule has a 'One-shot?' checkbox and a table for 'VARIABLE', 'COMP', and 'VALUE'. The 'during Descent' rule includes variables for 'Altitude (m)' and 'Speed vert (m/s)'. The right side contains 'Miscellaneous configurable Fluctus parameters' such as 'Radio channel', 'Radio output power', 'Mount orientation', 'Battery type', 'Pyro firing time (s)', 'Servo CLOSE angle', and 'Servo OPEN angle'. At the bottom, there are buttons for 'Save file...', 'Load file...', 'Upload', and 'Read', along with a 'Dual deployment' dropdown and a 'Show details' button.

RuleSystem configurator

Miscellaneous configurable Fluctus parameters

Load an example and show details

Saving and loading a configuration file

Read or write the configuration on Fluctus

3.5 - Fluctus configuration

Once you have successfully started Fluctus, as explained in [section 3.3](#), you can move on to the configuration step. After that the connection has been established, go to the Config tab.

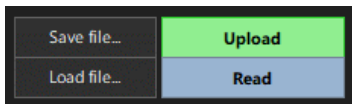

To read the current configuration of Fluctus, click on the “Read” button.

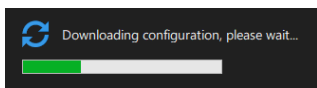

The configuration should download in less than ten seconds.

You can now edit the loaded configuration. The following parameters can be modified:

Parameter	Range	Description
Radio channel	ALPHA - ZULU	The radio channel on which Fluctus broadcasts and listens data
Radio output power	HIGH - LOW	Radio transmitting power
Mount orientation	2 orientations	Fluctus mounting orientation: antenna up or upside down on the Y axis (see next)
Battery type	Lithium 1S/2S, skip	Type of battery used. When this parameter is set to skip, the battery voltage check will be disabled.
Pyro firing time	0.1 - 10 seconds	Pyrotechnic output firing time (before auto shutdown)
Servo CLOSE/OPEN angle	0 - 180°	CLOSE or OPEN angle setpoint of a servo motor connected to a GP output
Countdown delay	0 - 300 seconds	Countdown time (sequencer time offset at launch)
Directly go to flight mode	Yes / No	Enables the "Flight Direct" option (see section 0.3) The countdown is automatically set to 0s
Low power mode	Yes / No	Disables display and RGB LED (less pwr. consumption)
Auto stop B-Box	Yes / No	Enables black box auto mode (see section 1.5)

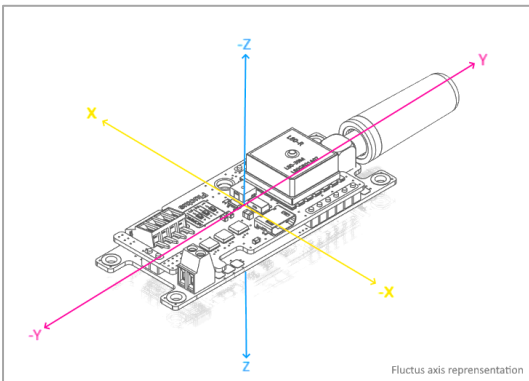

Some accelerometer functions need to know the exact orientation of Fluctus in your rocket. This orientation must be entered during configuration as explained above.

Antenna pointing upwards (Y) or downwards (-Y)

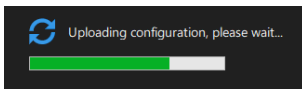

Once your configuration edited, send it to Fluctus. To do so, click “Upload”.

F.C.C. will send all the packets constituting the configuration in about ten seconds. Once Fluctus has received the configuration, it is processed and stored in flash memory. To finalize, the module restarts automatically.

To store and load multiple configuration profiles, the configurator also allows you to [save and load profile files](#) via these two buttons.

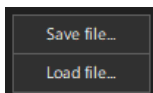

These profiles come in the form of .fcfg file, which are easy to copy and distribute.

When a configuration is sent to Fluctus, it is truncated in small packets, undergoing a multitude of checks. So, if an anomaly occurs during transmission, it will be explicitly indicated to you.

However, for reasons of reliability and safety (risk of user error), we recommend that you **do not** perform any operations on the configuration when you are far away, even less when your rocket is integrated and ready for launch.

3.6 - The RuleSystem

The RuleSystem manages all flight events and brings your rocket to life.

Its operating principle is relatively simple: **several rules are configured in a chain**. Each rule triggers a hardware or software output according to certain conditions. In addition, a "trigger mode" allows a rule to be linked to the flight sequencer.

In this way, complex mechanics can be programmed and executed by Fluctus, such as propulsion stage separation, payload release, deployment of multiple parachutes, remote actuator control, etc...

WARNING: The RuleSystem is operational from the moment Fluctus is armed and thus cannot be disengaged. This also means that a rule set to run at any time will run from the moment you arm the module.

Parameters available for each rule

TRIGGER MODE

As explained above, each rule can be configured to be triggered at a specific moment, or configured to run in a loop during a phase of the flight. In this case, the rules will be executed at each tick (so at a frequency of 40 Hz).

To link a rule to the sequencer, you can have it triggered by the following (yellow) events:

when Countdown end	When the sequencer countdown expires (at T +0s).
when Launch detected	When the rocket's launch (or "air start") is detected.
when Burnout	When an engine burnout is detected.
when Apogee	When flight apogee is detected.
when Touchdown	When the rocket completed its flight and touched down.
during Ascent	Continuously, during the rocket ascent phase.
during Descent	Continuous, during the rocket's descent phase.
Anytime	Continuous, from the moment Fluctus is armed.
when Trigger 1/2/3	When a rule triggers the 1/2/3 trigger.

ONE SHOT

In parallel with the trigger mode, you can check the "One shot" option to disable the rule just after its conditions have been validated the first time. The output will then be released.

Each rule can check up to 4 simultaneous conditions.

All these 4 conditions are checked with an AND or OR operator.

- The AND operator triggers output when ALL conditions are true.
- The OR operator will trigger output when ONE (or more) conditions are true.

Each of these conditions is made up of 3 elements: a variable, a comparator, and a value.

VARIABLE

The first thing that will define one of the rule's four conditions is the "variable". It's the flight computer's variable to which the condition will refer during comparison.

This variable can designate physical values (such as rocket altitude, speed, acceleration...), or software values (such as counters, timers...). Here's the list:

-	None, the condition is not configured.
Altitude	Altitude, from origin (in m)
Speed (vertical)	Vertical speed, relative to origin (in m/s)
Accel (global)	Global acceleration (in m/s ²)
Max angle	Maximum rocket displacement angle, relative to launch axis (in °)
Roll rate	Roll rate (in °/s)
Timer 1/2/3 value	Timer value 1/2/3 (in seconds)
Counter 1/2/3 value	Counter value 1/2/3
Command received	Value of last "radio command" received (default -1)
Analog 1/2 voltage	Voltage on analog input 1/2 (in millivolts)

COMPARATOR

The comparator, as its name suggests, compares the variable with the value.

For most variables, the only 2 comparators available are upper > and lower <. However, for convenience, an = comparator is available for counters and for the value of "radio command".

VALUE

The value to be compared to the variable via the comparator is a numerical constant, positive or negative, with 1 decimal place maximum.

OUTPUT AND MODES

As soon as the rule is checked and the condition table is valid (depending on the operator), Fluctus will instantly trigger the configured outputs.

A rule can manage up to 3 simultaneous outputs. Each of these outputs can have a "mode" to tune the action it will perform.

Output	Mode	Description
Disabled	-	No output is configured.
Pyro output x	Instant	Instantly triggers pyro out x during the set duration.
	+0.5s delay	Triggers pyro out x during the set duration, after 0.5s.
	+1s delay	Triggers pyro out x during the set duration, after 1s.
	+2s delay	Triggers pyro out x during the set duration, after 2s.
	+4s delay	Triggers pyro out x during the set duration, after 4s.
GP output x	Enable	Output x enabled, delivers a 3.3V DC signal.
	Disable	Output x disabled.
	Open servo	Controls a servo motor (on pin x) at OPEN angle.
	Close servo	Controls a servo motor (on pin x) at CLOSE angle.
Start timer x	-	Starts or resets timer x.
Counter x	Increment	Increments the x counter value by 1.
	Decrement	Decrements the x counter value by 1.
Rule Trigger x	-	Triggers rule trigger x
BlackBox Flag x	-	Records "Flag x" in the black box

(ABOUT RULE TRIGGERS)

- A rule trigger links several rules together, by connecting an output to a trigger mode. For example, if a rule is checked and its output is "Rule Trigger 2", then all rules whose trigger mode is "when Trigger 2" will be triggered.

(ABOUT COMMANDS)

- A RuleSystem command added to F.C.C. (see [REALTIME tab](#)) will have a unique ID associated with it (in the list, the first is ID 1, the second ID 2, the third ID 3...). To use a command, you can set up a rule that checks the "Command received" variable.
When a RuleSystem command is clicked in F.C.C., the "Command received" variable in Fluctus will be set to the value of the command ID.
 For example, if command no. 3 has been clicked, the "Command received" variable will be set to 3 (then automatically reset to -1).

(ABOUT TIMERS AND COUNTERS)

Among the variables of a flight rule, you'll find 3 timers and 3 counters.

- A timer is a variable representing the time elapsed since it was triggered (in seconds), with a resolution of 1 decimal place (0.1s). When a rule triggers a timer, but the timer is already counting, it will reset to 0 and restart automatically.
- A counter is an integer variable, which will increment or decrement depending on the output mode you've configured. It can be either positive or negative.



CONFIGURING A RULE CHAIN

In the Config tab, click on “Add a new rule” to add a new rule to the list. You can add up to a maximum of 10. To delete or move a rule, use the controls to the right of it.

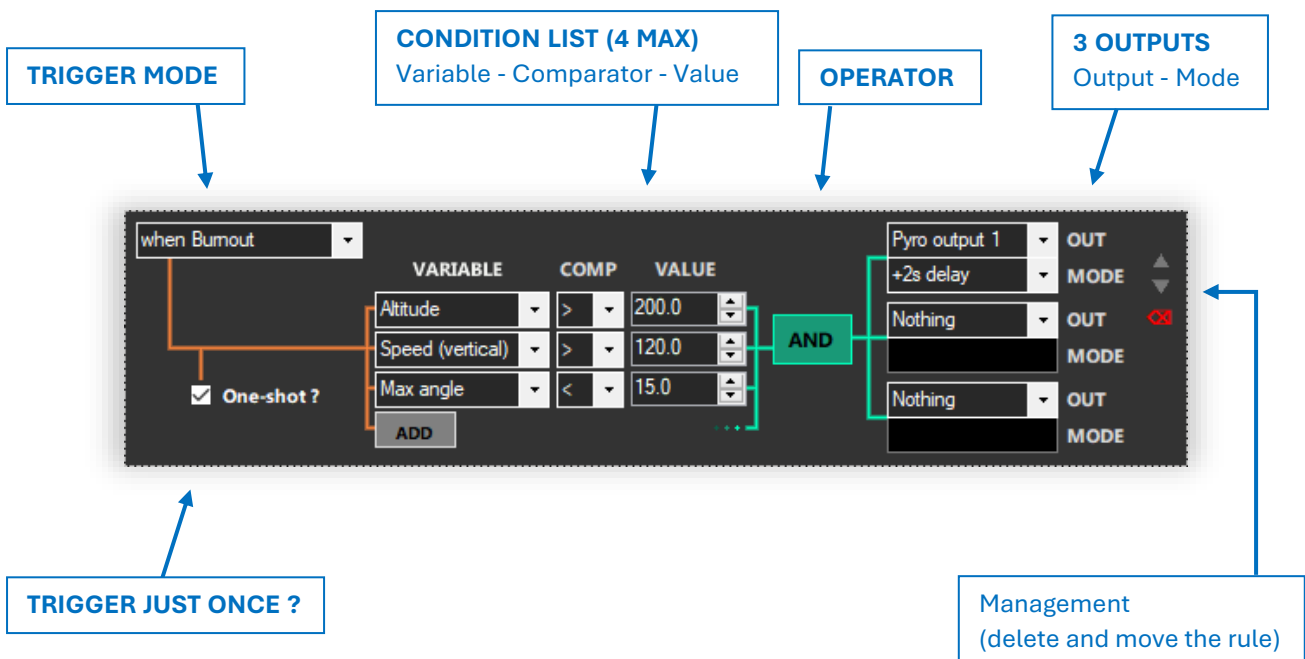

To add a condition to the list, click the “ADD” button.
 To remove it, open the VARIABLE combo-box and click “REMOVE”.

When 2 or more conditions are used, the operator appears, allowing you to set it to OR or AND.

The flight rules are sent at the same time as the rest of the configuration, so you can add and edit the rules, then send everything to Fluctus by clicking on "Upload". When you read a configuration, the rules are automatically placed back in the list so that you can edit them.

The amount of different RuleSystem configurations is:

4.61485 * 10²⁵⁹ possibilities

That's more than the number of atoms in the observable universe... Be creative!

If you're still wondering what kind of flight logic you can achieve with this ruling system, here's a typical example, along with a detailed commentary on how it works and how it behaves:

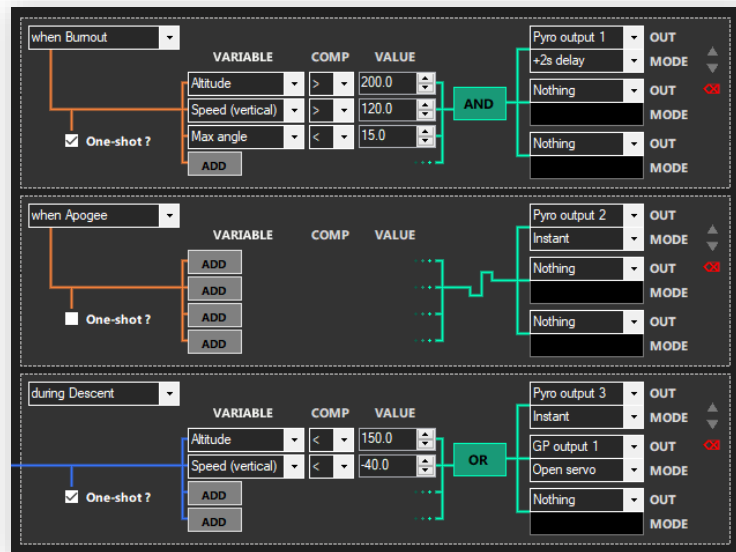

Rules explained:

When the motor burns out, the first rule will be triggered (as shown by its triggering mode). It verifies 3 conditions: if the rocket's altitude is greater than 200m, if the vertical speed is greater than 120m/s and if the rocket's maximum displacement angle is less than 15°. If ALL 3 conditions are true (because the operator is AND), the outputs will be triggered. In this case, the Pyro 1 is triggered after a 2-second delay. The "One-shot" parameter is ticked, so this rule will only run once.

When the flight apogee is reached, the second rule will be triggered. This rule has no conditions, so it will trigger outputs in all cases. The only output configured is the instantaneous firing of Pyro 2.

The third and final rule is checked at all times during the rocket's descent phase. The 2 configured conditions check if the rocket altitude falls below 150m OR if the vertical speed falls below -40m/s. If either of these two conditions is true, then the rule will trigger the 2 configured outputs: instant fire of Pyro 3 and rotation of a servomotor on GP pin 1 to the "OPEN" angle. Since "one-shot" option is enabled, the rule will be ignored as soon as its outputs are triggered for the first time. This prevents the pyrotechnic output from remaining fired throughout the rest of the descent.

In other words, here's what this logic does:

- If the motor burns out at more than 200m, while the rocket is going faster than 120m/s and if the maximum tilt is less than 15°, then Pyro 1 will be fired within 2 seconds (**rule 1**).
- When the apogee of the flight is reached, Pyro 2 will fire instantly (**rule 2**).
- As soon as the rocket's altitude falls below 150m during descent or if the rocket is falling faster than 40m/s, the Pyro 3 will instantly fire (once) and the servo on GP1 will turn to the "OPEN" angle (**rule 3**).

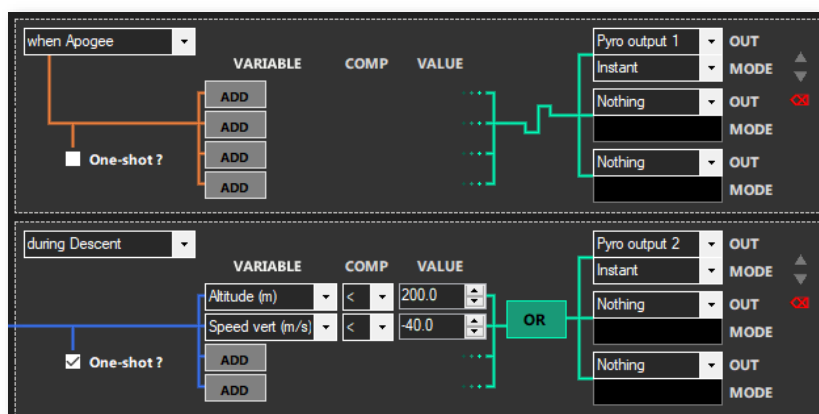

BASIC DUAL DEPLOYMENT EXAMPLE

Logic overview:

This logic handles dual parachute deployment. Here's an overview of its behavior:

At the apogee of the flight, Fluctus will trigger pyrotechnic output 1, to fire an igniter and eject the Drogue parachute.

During the rocket's descent, when the altitude falls below 200m OR if the rocket drops at more than 40m/s (which would mean that the ejection of the Drogue parachute has failed), Fluctus will fire pyrotechnic output 2 to eject the Main parachute.

Rule 1 explained:

This first rule of the dual deployment logic is configured to be triggered at apogee, as evidenced by its trigger mode set to "when Apogee".

This rule has no conditions, so it will inevitably activate the outputs as soon as it is triggered by apogee detection.

Only one output is configured to this rule: "Pyro output 1", in "Instant" mode, which means that this rule will instantly trigger pyrotechnic output n°1 to fire a charge connected to it and eject the Drogue parachute.

Rule 2 explained:

This second rule controls the ejection of the Main parachute. It will be checked continuously throughout the rocket's descent, as evidenced by its "during Descent" triggering mode.

The rule has 2 conditions. The first checks if the altitude is below a threshold of 200m, and the second checks if the rocket falls at a vertical speed of less than -40m/s (which would mean, in this case, that the Drogue parachute has failed).

Since the verification mode is set to "OR", the rule will trigger its outputs if either of the two conditions is met.

Only one output is configured to this rule: "Pyro output 2", in "Instant" mode, which means that this rule will instantly trigger pyrotechnic output n°2 after one of the two conditions is met, and eject the Main parachute.

The "One-shot" checkbox is ticked to ensure that this rule is satisfied only once, and doesn't keep running for nothing afterwards.

3 STAGE ROCKET EXAMPLE

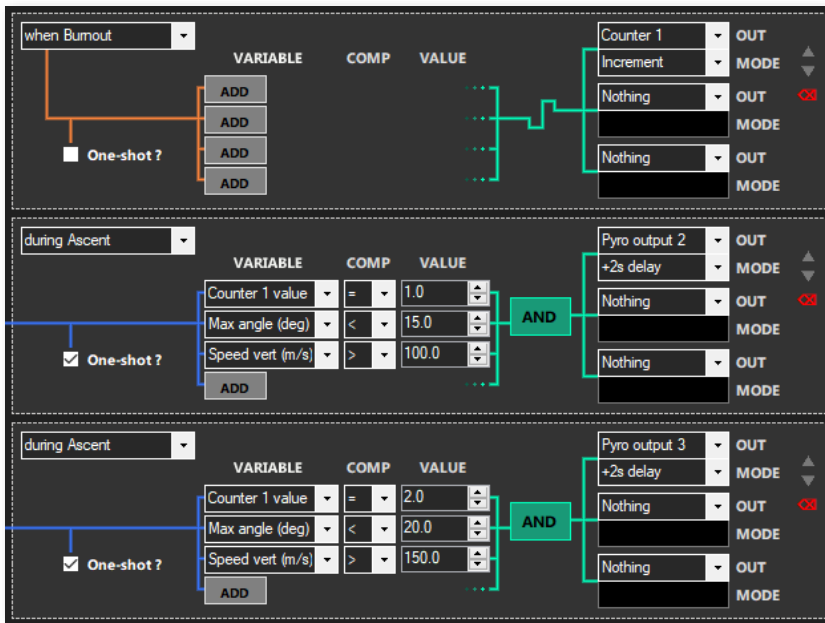

Logic overview:

This logic handles the ignitions of a 3-stage rocket engine. Here's an overview of its behavior: 2 seconds after the burnout of the first stage, if the rocket has only inclined at an angle of less than 15°, AND if the rocket is climbing at a speed of over 100m/s, then Fluctus will trigger pyrotechnic output 2 to ignite the second stage. Then, 2 seconds after burnout of the second stage, if the rocket has only tilted at an angle of less than 20°, AND if the rocket is climbing at a speed of more than 150m/s, Fluctus will trigger pyrotechnic output 3 to fire the third stage.

Rule 1 explained:

The first rule of this staging logic is triggered by engine burnouts, as evidenced by its "when Burnout" trigger mode. This rule has no conditions, so it will inevitably trigger its outputs as soon as it is triggered. Only one output is configured: "Counter 1", set to "Increment" mode. In this way, the software counter n°1 will be incremented each time a burnout is detected (so it will have the value 1 after the first engine burnout, then 2 after the second, etc.).

Rule 2 explained:

The second rule of this logic controls the ignition of the second stage. Its triggering mode is set to "during Ascent", which means that it will be checked continuously during the rocket's ascent. The rule has 3 conditions. The first checks whether the value of "Counter 1" is equal to 1, which in this context will be true as soon as the first burnout is detected (i.e. when Rule 1 has incremented "Counter 1", as shown previously) The second and third conditions check flight parameters: if the rocket's maximum angle of inclination is less than 15°, and if the rocket's vertical speed is greater than 100m/s. The check mode of this rule is set to "AND", which means that its outputs will be activated when ALL the above conditions are met.

Only one output is configured to this rule: "Pyro output 2", in "+2s delay" mode, which means that this rule will trigger pyrotechnic output n°2 exactly 2 seconds after ALL of the three conditions are met, and so igniting the second stage engine.

The "One-shot" checkbox is ticked to ensure that this rule is satisfied only once, and doesn't keep running for nothing afterwards.

Rule 3 explained:

The third rule controls ignition of the third stage.

Its principle is the same as that of Rule 2 for second-stage ignition.

The major difference is that here, we check whether "Counter 1" has a value equal to 2. This way, this rule can only be satisfied after the second burnout detection (i.e. the burnout of the second-stage engine).

Unlike Rule 2, this one will finally trigger "Pyro output 3" if the rocket's maximum angle of inclination is below 20°, and if vertical velocity is above 150m/s.

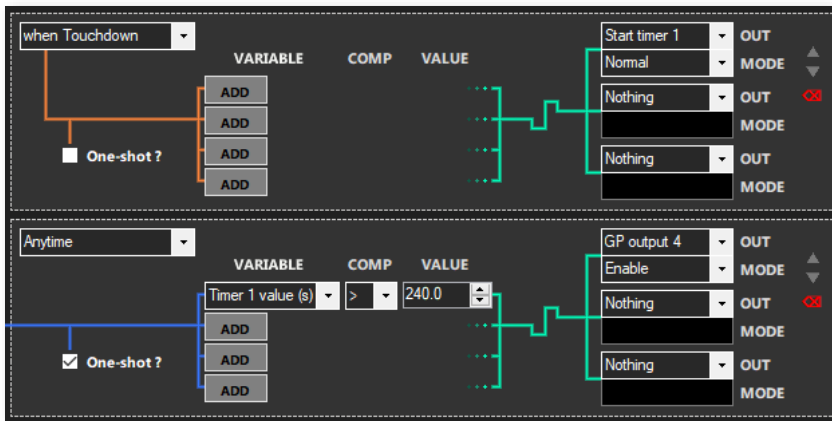

RECOVERY BUZZER EXAMPLE

Logic overview:

This logic handles a buzzer that activates 4 minutes after the rocket has landed. The buzzer would be driven by Fluctus' GP4 output.

Rule 1 explained:

The first rule of this logic is checked when the rocket touches down, as evidenced by its trigger mode set to "when Touchdown". This rule has no conditions, so its outputs will inevitably be activated after touchdown. The only output of this rule is "Start timer 1". In this way, when the rocket lands, the rule will trigger the software timer n°1, which will then start counting.

Rule 2 explained:

The second rule of this logic is continuously checked at all times, as evidenced by its trigger mode set to "Anytime". This rule has one condition, which checks whether the value of "Timer 1" is greater than 240 seconds. In this way, this rule will be satisfied exactly 240 seconds after the touchdown, since software timer n°1 started counting from the moment the rocket landed, as specified in Rule 1. The only output configured is "GP output 4" in "Enable" mode, enabling the GP4 output to emit an electrical signal as soon as the rule is satisfied. The "One-shot" checkbox is ticked to ensure that this rule is satisfied only once, and doesn't keep running for nothing afterwards.

3.7 - Downloading and opening BlackBox data

F.C.C.'s **BlackBox Viewer** will help you download, analyze, and export your flight data.

Downloading the black box from your last flight:

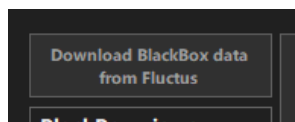

Start F.C.C and connect Fluctus to your computer via its USB connector.
 Select the Fluctus USB port in the bottom right-hand corner and click on “Download BlackBox data from Fluctus”.

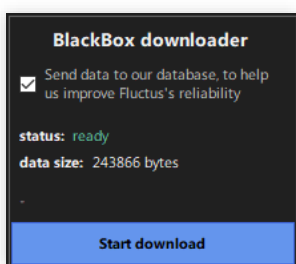

Wait a few seconds.
 The download tool should appear.
 Click on “Start download”.

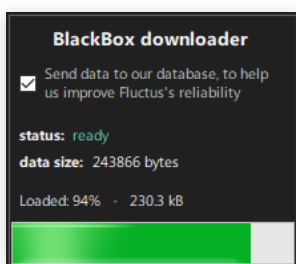

The download will start.
DON'T TOUCH ANYTHING!
 The operation will take varying amounts of time depending on the duration of your flight.

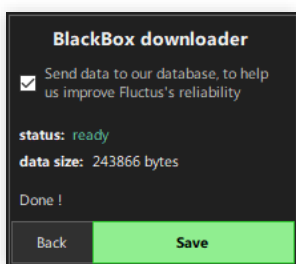

Once the download is complete, save the data by clicking on “Save”. The data will be saved as an .fbb file.
The black box is transferred!
 You can now return to F.C.C. by clicking on "Back"

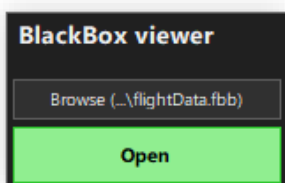

To open these data: go to the F.C.C. menu.
 In the “BlackBox viewer” box, click on “Browse” and select the .fbb file containing your flight data. Then press “Open”.

3.8 - The BlackBox Viewer

The **Overview** tab gives you access to a summary of the flight, thanks to a timeline and data on altitude, speed, acceleration, rocket angle, propulsion, and launch conditions.

If the BlackBox Viewer detects anything unexpected on your flight, it will indicate this in the "hot spots" area.

The screenshot shows the 'BlackBox viewer' interface with the 'Overview' tab selected. The interface includes a navigation bar with tabs for Overview, Graphs, Config - Flags, Tools, Settings - Export, 3D, and a Back button. A flight timeline at the top shows stages: Countdown (T -0.6), CtDw + Wait (0.6s), Launch detected (T 0.0s), ASCENT (14.5s), Apogee (T 14.5), DESCENT (92.8s), and Touchdown (T 107.2). A clock icon indicates the flight duration: 'Flew during 107.2s on 01-01-2000, 00:00'. Key flight data is displayed in large text: 951.5 meters in 14.5s (apogee altitude), 151.1 m/s (maximum vertical speed), -5.6 m/s (touchdown speed), 14.1 G (maximum acceleration), and 437 °/s (angle at burnout with a maximum roll rate of 3). A 'HOT SPOTS' section shows 'Nothing relevant detected.' and an 'AT LAUNCH' section shows temperature: 18.1 °c, battery voltage: 4.14 V, and pyro continuity: OK 1, NC 2, OK 3. Callouts point to the 'Common header' (navigation tabs), 'Flight timeline' (top timeline), 'Key flight data' (large statistics), and 'Propulsion characteristics Flight Hot Spots Launch conditions' (right-hand panels).

The **Graphs** tab lets you plot up to 3 graphs simultaneously, of any value.

For each graph, a point will moves across the curve to the “Timeline” frame. The value of the vertical and horizontal axis is displayed just below, along with the two extremes of the value.

Clicking on the "Zoom" button below one of the graphs enlarges the scale of the horizontal axis with a factor of 1, 2, 4, 8, 16 or 32.

The "Timeline" at the bottom of the interface lets you move through time (indicated by the blue marker). 4 markers for arming, launch detection, apogee and touchdown are placed on the timeline to make it easier to find your way around.

On the right of the timeline, the frame number and time (relative to the black box’s start time) are displayed.

To move through time, simply drag your cursor on the Timeline by holding down the left mouse button, or use your scroll wheel or the 2 bottom-right arrows.

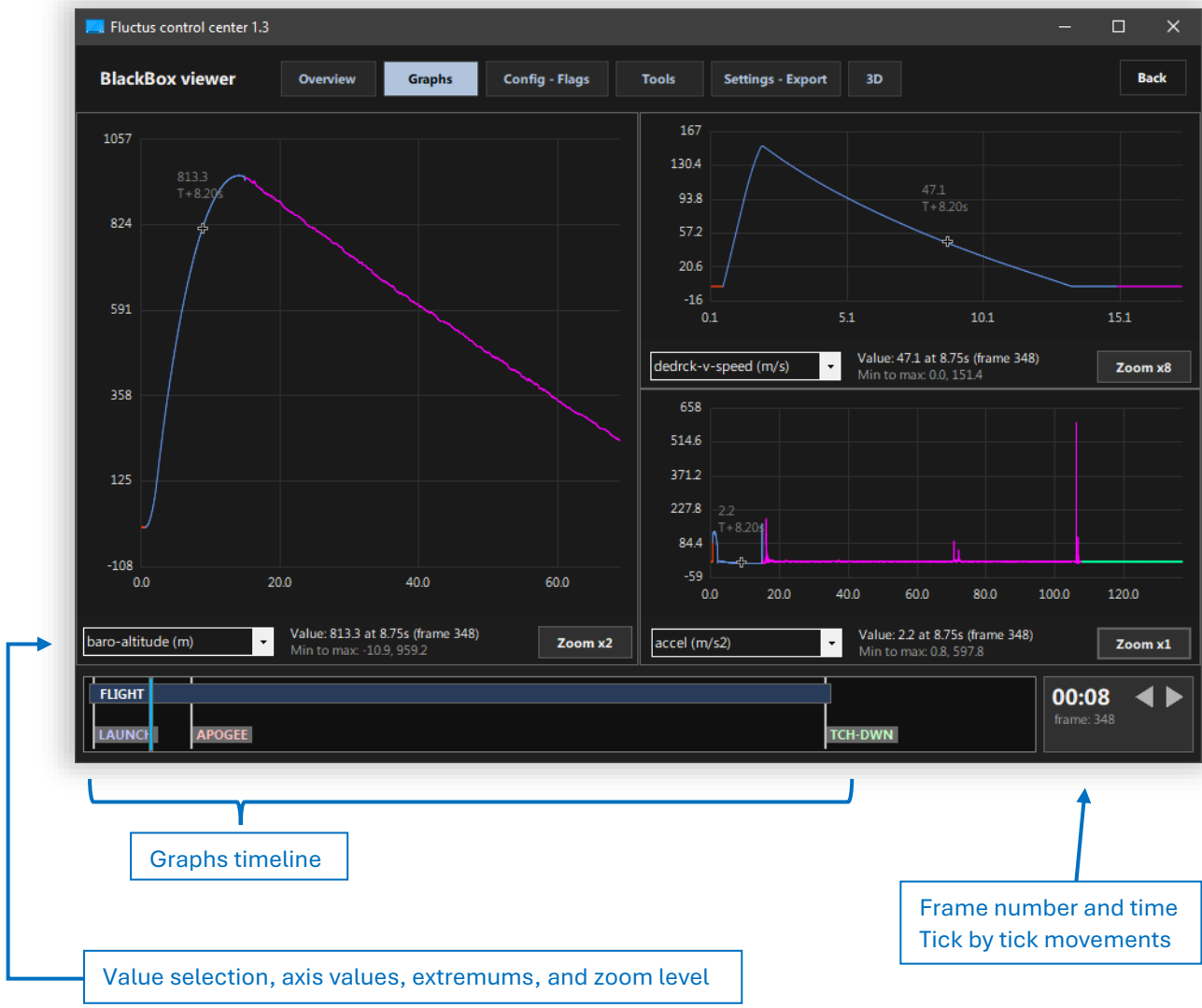

The **Config - Flags** tab displays the Fluctus configuration used at launch (parameters and rules), as well as a list of all Flags written during the flight. Each Flag is listed with its **relative to launch** time.

FLIGHT CONFIG

Manual mode, countdown 0.0s
 BlackBox auto, energy saving mode
 Radio on FOXTROT, HIGH power
 Mounted Ant. UP, battery Li 1S
 Pyro delay of 1.0s, servo 0/180°

FLIGHT FLAGS

0	Launch	T- 0.0s
0	App. dtct. vel. lockout	T+ 0.1s
0	Flag 2	T+ 1.5s
0	Burnout	T+ 1.5s
0	App. dtct. GO	T+ 11.0s
0	Flag 0	T+ 14.4s
0	Apogee	T+ 14.4s
0	Flag 1	T+ 70.0s
0	Touchdown	T+ 107.2s
0	BBox end, code: 0	T+ 137.4s

02/04

VARIABLE	COMP	VALUE	OUT	MODE
Altitude (m)	<	214.0	Pyro output 3	OUT
			Instant	MODE
			Blackbox Flag 2	OUT
			Normal	MODE
			Nothing	OUT
				MODE

during Descent

One-shot?

ADD

ADD

ADD

Callout boxes:

- List of flight rules (use the arrows to scroll)
- List of Flags recorded during the flight
- Fluctus configuration used for the flight

The **Tools** tab gives you access to various measurement tools based on your flight data.

The first tool is used to determine engine thrust during flight. It considers the different acceleration phases and vehicle parameters (masses and aerodynamic characteristics) you enter, to give you the best possible estimate. **Note that typically, this thrust calculation tool will measure a total impulse about 15% to 20% lower than the actual performance.**

The second tool allows you to determine the drag coefficient of your rocket using the deceleration data undergone during burnout.

Engine thrust calculation tool
Aerodynamic drag coefficient calculation tool

The screenshot shows the 'Fluctus control center 1.3' interface. The 'Tools' tab is active, displaying two calculation tools. The 'Engines thrust calculation' tool shows a status of 'CALCULATION DONE' and a 'Burn #1' dropdown. Below it, calculation parameters for burn #1 are listed: Vehicle start mass (g) at 2850, Vehicle dry mass (g) at 2100, Vehicle aero coefficient at 0.78, and Vehicle aero surface (cm²) at 24.0. A 'CALCULATE - BURN #1' button is present. Below the parameters, summary statistics are shown: Total impulse*: 366 Ns, Burn duration: 1.45 s, and Average thrust: 253 N. A line graph plots thrust over time from 0.0 to 1.6 seconds, with values ranging from -30 to 325. The 'Aerodynamic drag coefficient calculation' tool shows calculation parameters at burnout #1: Vehicle dry mass (g) at 2100 and Vehicle aero surface (cm²) at 24.0. A 'CALCULATE' button is present. Below it, the results are: Drag coefficient: 0.78, Df 22.1 N, V 141.1 m/s, and ϕ 1.18 kg/m³. A note states: '* The thrust calculation typically underestimates the total impulse by 15 to 20%.'

The **Export - Settings** tab gives access to file read parameters, as well as to .CSV flight data export (which can be opened in any spreadsheet program, such as Excel) and to flight configuration export (.fcfg file, which can be reused in Fluctus).

Depending on the region of your spreadsheet program, the standards for .csv files change. If the import is not correct, change the "Decimal point delimiter" parameter before re-exporting the file.

Flight data export (.csv)
Fluctus configuration export (.fcfg)
Read/Display settings

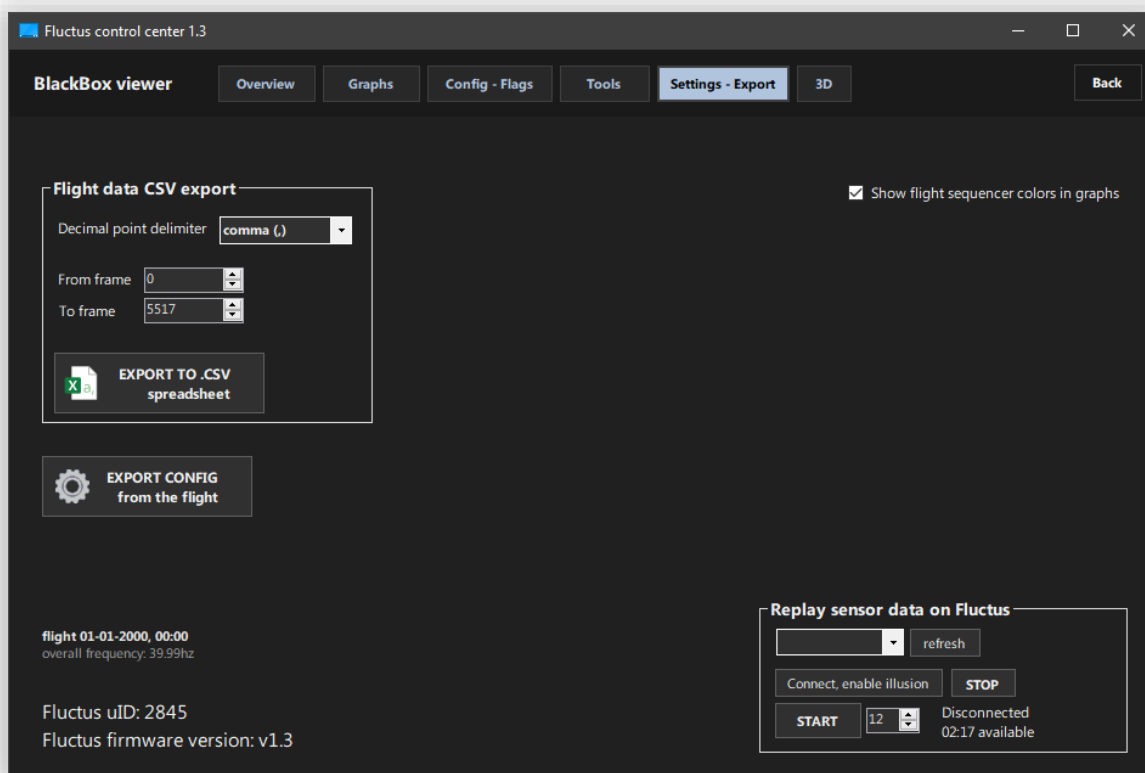

Fluctus unique ID and firmware version

EXPERIMENTAL - DO NOT USE

The **3D** tab gives you a view of your rocket's trajectory. You can move around the map using the controls shown below the viewport. This feature is only available on the latest installations of Windows 10.

The trajectory takes on a different color depending on the phase of flight.

- **Turquoise** → ascent powered
- **Blue** → ascent
- **Orange** → descent

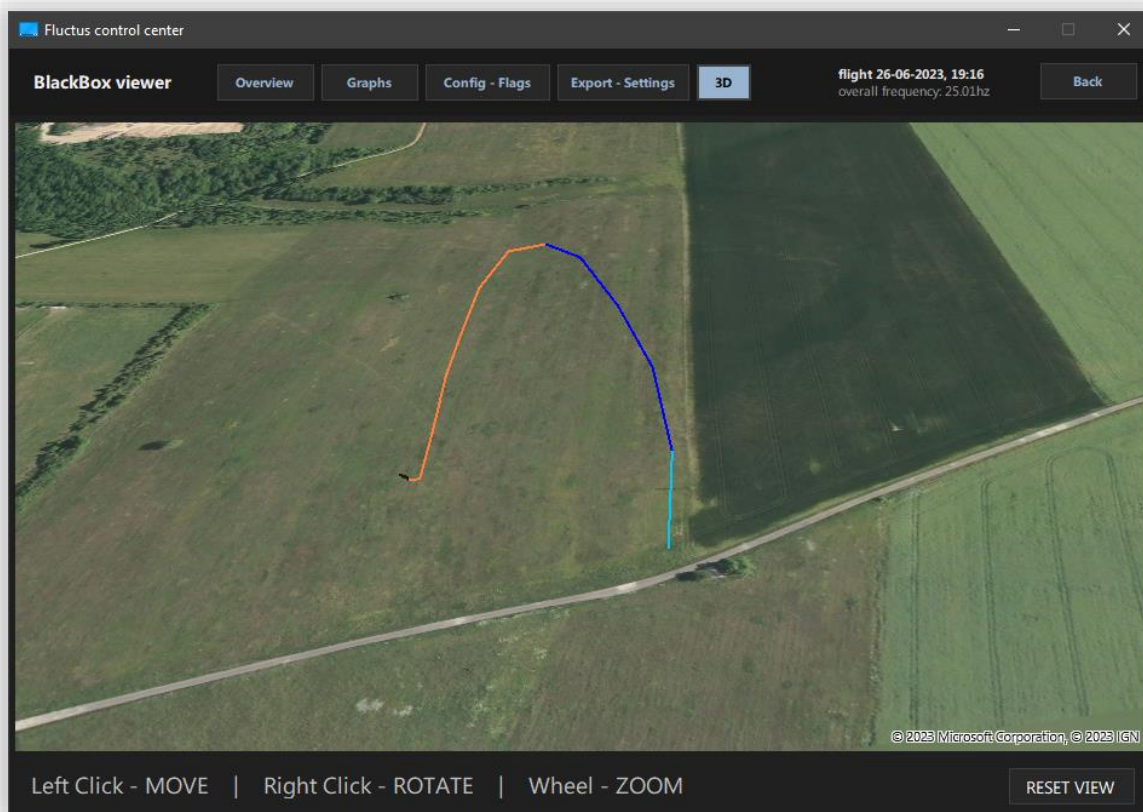

Restore view to its original position

4.1 - Typical examples

Most complex use case (manual)

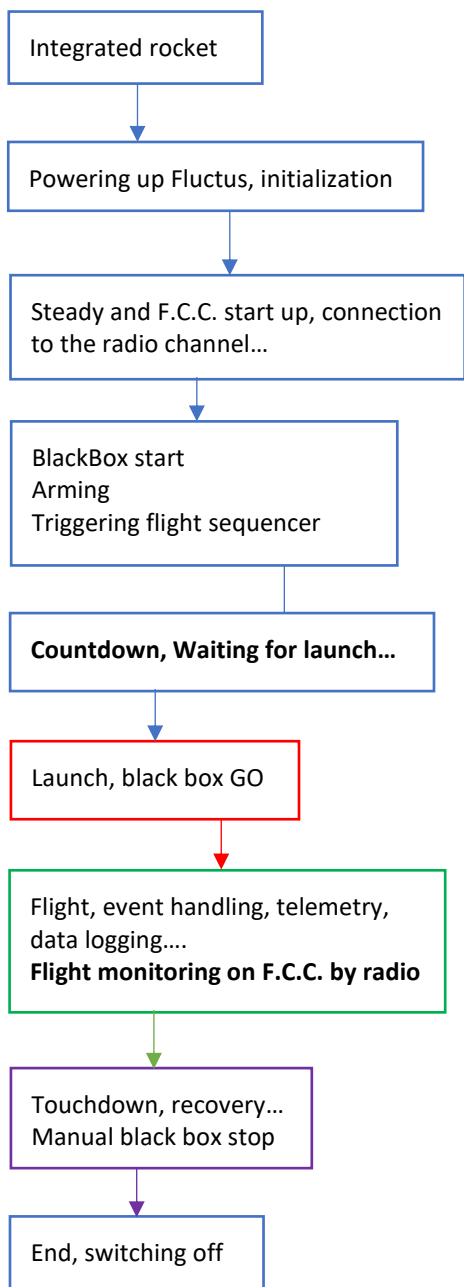

Most simple use case (flight direct + bbox auto)

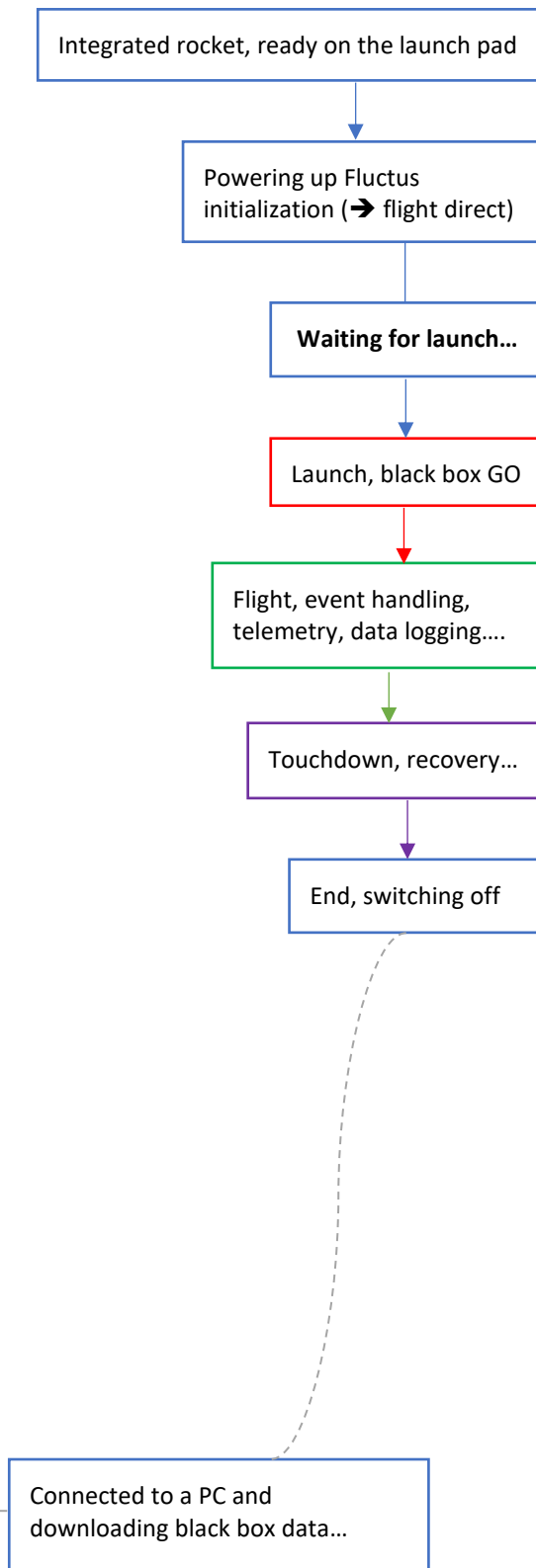

4.2 - Frequently Asked Questions

- *“Fluctus doesn’t receive all GPS signals, can I still launch my rocket ?”*

Yes, you can launch your rocket even if the GPS satellites signals aren’t locked, as the GPS system is not required for Fluctus to function properly during flight.

Nevertheless, it is advisable to wait for the GPS to pick up signals before launch, to maximize location reliability once the rocket is on the ground and to log trajectory data in the black box.

- *“I can’t get the flight computer or ground station to connect to my computer, and the drivers seem to be missing. What can I do ?”*

If you're having trouble with your computer’s USB drivers, reinstall them by following this procedure:

- Download the Zadig 2.8 tool (<https://zadig.akeo.ie/>)
- Open the executable.
- Under « options », select « list all devices ».
- Make sure that the Steady ground station is connected to your computer (use the provided cable or any other trusted one).
- In the dropdown, select « Steady USB ».
- Select the driver « USB Serial (CDC) ».
- Click on Update or Downgrade driver.
- Wait until the process is done, then disconnect and reconnect Steady, and check if the port shows up. If the issue still persists, feel free to contact us for further assistance.

4.3 - Resources

3D files (.step, .stl)

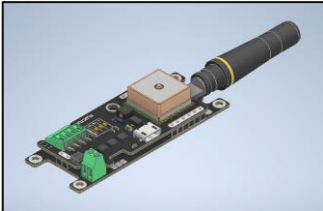

Fluctus [standard]

https://silicyne.net/resources/fluctus_cadmodel_standard.stp



Steady [standard antenna, with pads]

https://silicyne.net/resources/steady_cadmodel_stdantpad.stp

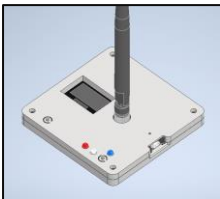

Steady protective casing v2 [3D printable]

https://silicyne.net/resources/steady_3dcase_stl.zip