

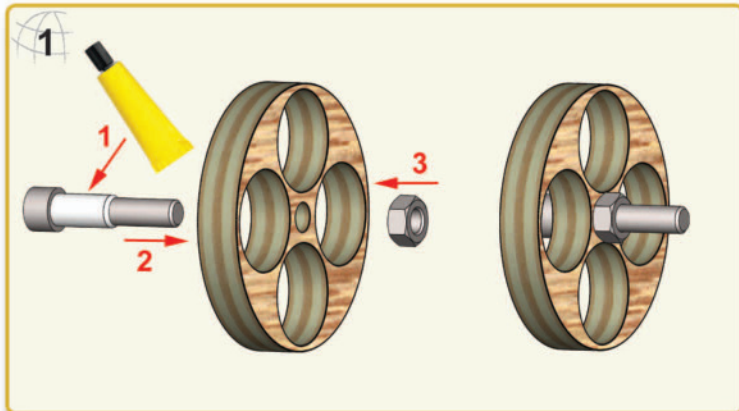



Bauanleitung Assembly Instructions Notice de montage Istruzioni di montaggio Instrucciones de montaje

Erforderliche Materialien für den Zusammenbau
Required materials for assembly
Matériaux nécessaires à l'assemblage
Materiali richiesti per il montaggio
Materiales necesarios para el montaje



 Etwas Klebstoff (Epoxidharz) auf die Schraube auftragen und durch das Loch des hinteren Motorspant stecken. Mutter anschrauben und fest anziehen.

 Apply some epoxy glue to the screw and push it through the hole of the aft motor bulkhead. Screw on the nut and tighten.

 Appliquer de la colle époxy sur la vis et la glisser à travers le trou de la cloison arrière du support-moteur. Vissez l'écrou et serrez.

 Aplique un poco de cola epoxy al tornillo y empuje a través del agujero del mamparo del motor en popa. Enrosque la tuerca y apriete.

 Applicare della colla epossidica sulla vite e spingerla attraverso il foro della paratia posteriore del supporto motore. Avvitare il dado e serrare.

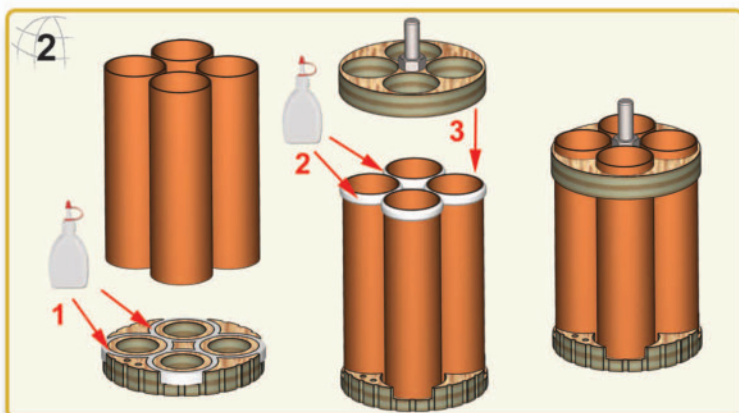

 Am vorderen Motorspant wie abgebildet Klebstoff (Holzleim) auftragen und Motorrohre aufstecken. Am hinteren Ende der Motorrohre umlaufend Klebstoff auftragen und den hinteren Spant ankleben. Der Spant sollte bündig mit diesen sein, bzw. sollten die Motorrohre maximal 3mm überstehen. Anschließend von beiden Seiten eine umlaufende Klebstoff-Raupe anbringen und zum Trocknen beiseitelegen.

 Apply some wood glue to the front bulkhead as pictured and insert the motor tubes. Then apply some beads of wood glue at the rear ends of the motor tubes and glue on the rear bulkhead. The bulkhead should either be flush with the tubes should only stick out by no more than 3mm. The apply some fillets of wood glue to all joints and set aside to dry.

 Appliquer de la colle à bois sur la cloison avant comme illustré et insérer les tubes support-moteur. Ensuite, appliquer des cordons de colle à bois aux extrémités arrière des tubes support-moteur et sur la cloison arrière. La cloison doit être alignée avec les tubes, mais ne doit être enfoncée de plus de 3 mm. Appliquer des filets de colle de bois sur tous les joints et laisser sécher.

 Aplique un poco de pegamento de madera al mamparo delantero como se ilustra e inserte los tubos del motor. A continuación, aplique algunas perlas de pegamento de madera en los extremos traseros de los tubos del motor y cola en el mamparo trasero. El mamparo debe estar al ras con los tubos debe sobresalir por no más de 3 mm. La aplicación de algunos filetes de pegamento de madera a todas las articulaciones y dejar a un lado para secar.

 Applicare un po' di colla per legno alla paratia anteriore del supporto motore come illustrato nel disegno e inserire i tubi portamotori. Quindi applicare uno strato di colla di legno sulle estremità posteriori dei tubi motore ed incollare la paratia posteriore. La paratia può essere a filo con i tubi oppure questi possono sporgere per 3 mm al massimo. Applicare filetti di colla per legno lungo tutte le giunture e mettere da parte ad asciugare.

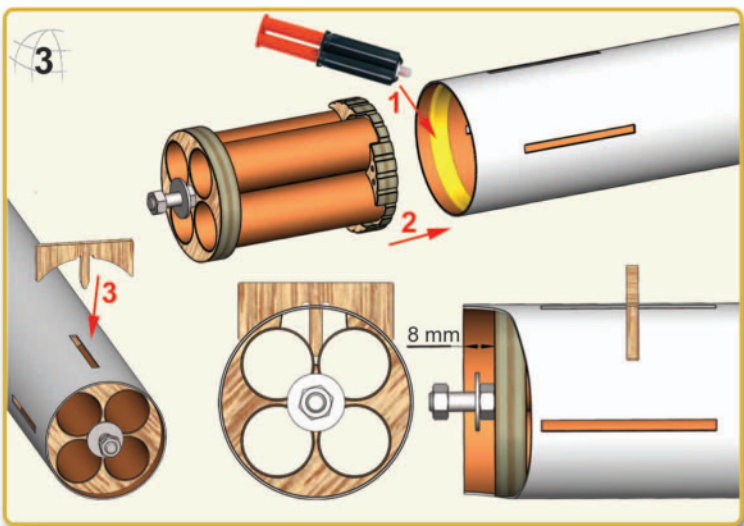

 Die fertige Motorhalterung mit Epoxidharzkleber in das Körperrohr einkleben. Die Motorhalterung mit Hilfe des mitgelieferten Werkzeugs wie abgebildet zu den Schlitzten ausrichten.

 Glue the assembled motor mount in to the body tube with epoxy glue. Use the provided tool for aligning the motor mount correctly to the slots in the airframe as pictured.

 Coller l'ensemble support moteur assemblé dans le tube du corps avec de la colle époxy. Utilisez le gabarit fourni pour fixer le support du moteur sur les fentes correctement du tube du corps comme illustré.

 Pegue el montaje del motor montado en el tubo del cuerpo con pegamento epoxi. Utilice la herramienta suministrada para alinear el montaje del motor correctamente a las ranuras del tubo del cuerpo como se ilustra.

 Incollate il supporto motore finito nel tubo fusoliera, utilizzando colla epossidica. Utilizzare lo strumento fornito per allineare correttamente il supporto del motore alle fessure del tubo del corpo come illustrato.

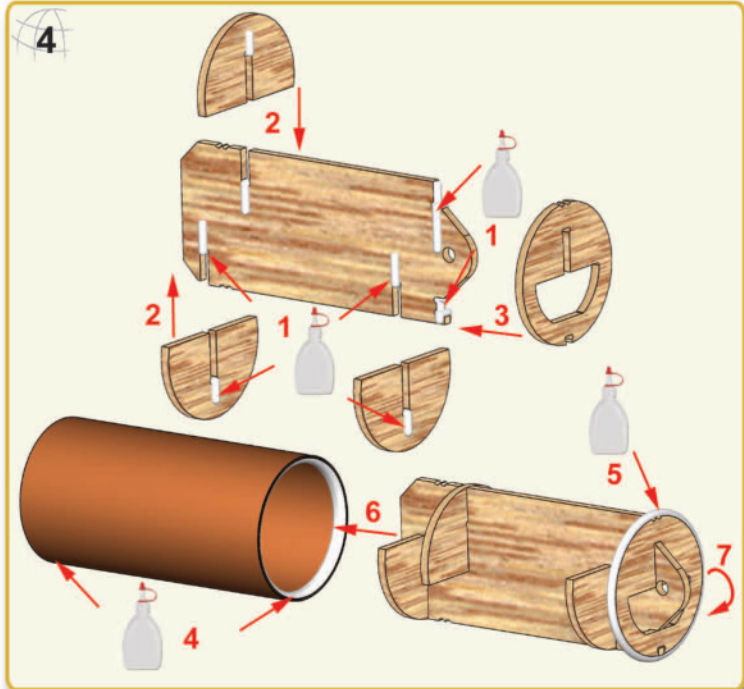

 Die Halbkreis-Scheiben an der zentralen Stütze wie abgebildet kleben. Die vordere Scheibe richtig herum einkleben. Dann in jedem Ende des Rohr-Kupplers eine Klebstoff-Raupe auftragen. Beim Einführen des Fallschirm-Schutzes gleichzeitig um eine Umdrehung drehen.

 Glue the half-circular discs to the central spar as pictured. Be sure that the forward disc is glued in the proper way around. Then apply a bead of glue inside both ends of the tube coupler. When inserting the baffle in to the coupler, do a twisting motion of one rotation at the same time.

 Coller les couples demi-circulaires sur le longeron central comme illustré. S'assurer que le disque avant est collé de manière appropriée. Ensuite, appliquer un cordon de colle à l'intérieur des deux extrémités du coupleur de tube. Lorsque le déflecteur est inséré dans le coupleur, effectuer un mouvement de torsion et de rotation en même temps.

 Pegue los discos semicirculares en el larguero central como se ilustra. Asegúrese de que el disco delantero esté pegado de la manera adecuada. A continuación, aplique un cordón de pegamento dentro de ambos extremos del acoplador de tubo. Al insertar el deflector en el acoplador, haga un movimiento de torsión de una rotación al mismo tiempo.

 Incollare i dischi semicirculari del deflettore di protezione del paracadute alla sezione centrale, come illustrato. Assicurarsi che il disco anteriore sia incollato tutto intorno correttamente. Quindi applicare un filetto di colla all'interno di entrambe le estremità del tubo accoppiatore. Mentre si inserisce il deflettore nell'accoppiatore, eseguire contemporaneamente un movimento rotatorio facendo compiere un giro completo.

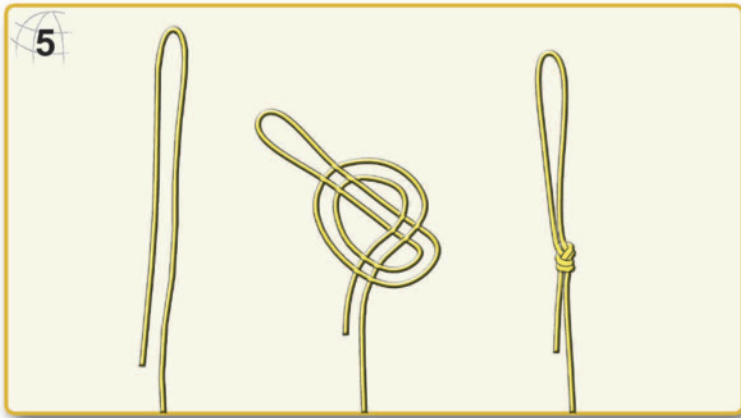

 In die Kevlar-Schnur eine Schlaufe binden.

 Tie a noose on one end of the Kevlar cord.

 Effectuer un nœud en queue de vache à une extrémité du cordon de Kevlar.

 Ate un nudo en un extremo del cordón de Kevlar.

 Formate un cappio ad un'estremità del cavo di Kevlar.

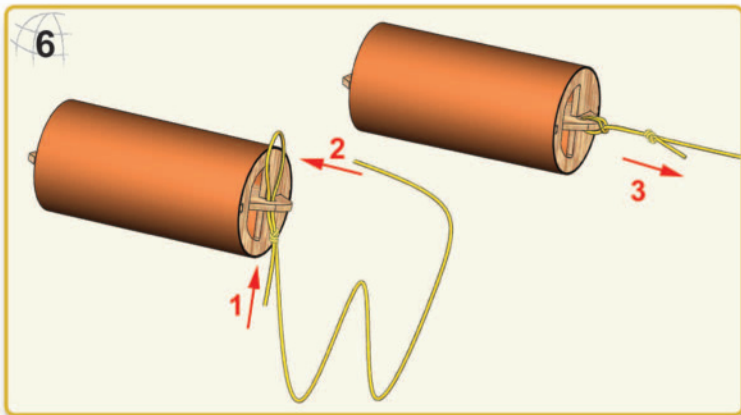

 Die Schlaufe mit einem Ankerstich an die Öse des Fallschirmschutzes befestigen.

 Attach the noose to the baffle with a cow hitch as pictured.

 Passer la boucle dans le trou du déflecteur puis glisser l'extrémité du cordon dedans pour fermer le nœud comme indiqué.

 Fije el lazo al deflector con un enganche de vaca como se ilustra.

 Fissate il cappio nel foro del deflettore con un nodo, come nella immagine.

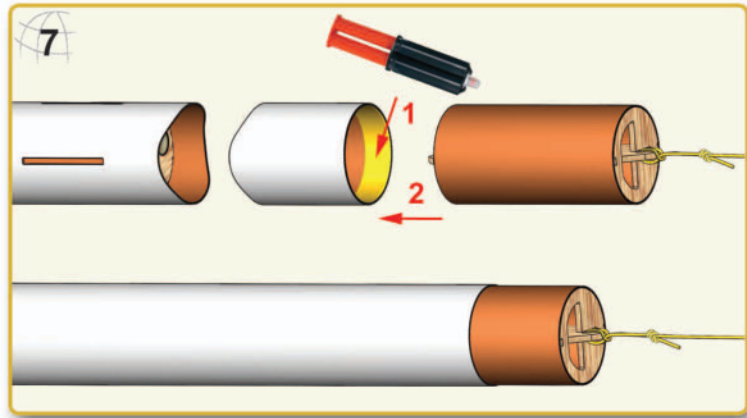

 Den fertigen Fallschirmschutz im unteren Körperrohr wie abgebildet einkleben, jedoch nur zur Hälfte einschieben.

 Now glue the completed baffle in to the lower body tube as pictured, but leave half of it sticking out.

 Maintenant, coller le déflecteur complet dans le tube inférieur de la fusée comme sur la photo, mais laisser la moitié de celui-ci dépasser.

 Ahora pegue el deflector completado en el tubo del cuerpo inferior como se ilustra, pero deje la mitad de él sobresaliendo.

 Ora incollare il deflettore completato al tubo inferiore del corpo del razzo come illustrato, lasciandone sporgere metà.

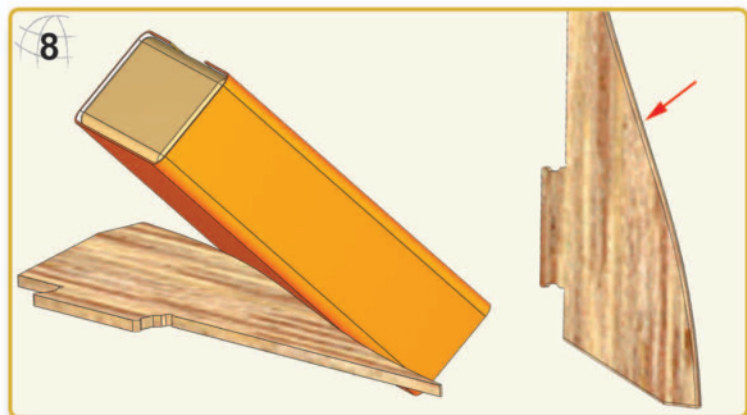

 An dieser Stelle kann man entscheiden ob die Kanten eckig bleiben, gerundet werden, eine Fase, oder sogar eine Stromlinienform erhalten. Am besten geht es mit einem Schleifklotz.

 At this stage you can choose whether you want to leave the fin edges square, make them rounded, bevel them or even streamline them. Use a sanding block.

 A ce stade, vous pouvez choisir de laisser le bord des ailettes saillant, de l'arrondir, de le biseauter ou même de le profiler. Utiliser une cale à poncer.

 En esta etapa puede elegir si desea dejar los bordes de las aletas cuadradas, hacerlas redondeadas, biselarlas o incluso optimizarlas. Utilice un bloque de lijado.

 A questo punto è possibile scegliere se si desidera lasciare le alette così come sono, oppure arrotondare o smussare il profilo, o addirittura profilarlo a sezione alare. Per queste operazioni usate un blocco per levigatura.

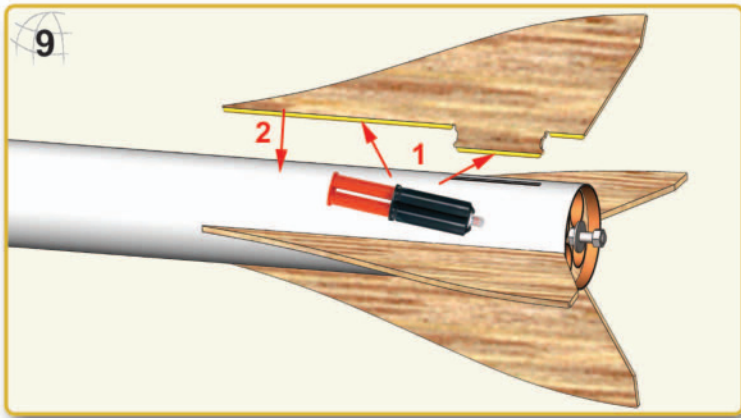

Deutsch Etwas Holzleim entlang der Wurzel und Lasche einer Flosse auftragen und durch einen Schlitz im Körperrohr stecken. Darauf achten, dass jede Flosse gut aufsitzt und zwecks guter Haftung im korrekten Winkel zum Rohr aufgeklebt wird. Mit jeder Flosse wiederholen. Klebstoff trocknen lassen.

English Apply some wood glue along the root edge and tab of each fin and stick them in to the slots as pictured. Make sure each fin is seated firmly and at the correct angle on to the body tube for proper adhesion. Repeat with each fin. Let the glue dry.

Français Appliquer un peu de colle à bois le long du bord de la racine et l'onglet de chaque ailette et les coller dans les fentes comme illustré. Assurez-vous que chaque ailette est assis fermement et à l'angle correct sur le tube du corps pour une bonne adhérence. Répéter l'opération avec chaque ailette. Laisser sécher la colle.

Español Aplique un poco de pegamento de madera a lo largo del borde de la raíz y la lengüeta de cada aleta y pegarlas adentro a las ranuras según lo representado. Asegúrese de que cada aleta está firmemente asentada y en el ángulo correcto en el tubo del cuerpo para la adhesión adecuada. Repita con cada aleta. Deje que el pegamento se seque.

Italiano Applicare un po' colla di legno lungo il bordo radice e scheda di ogni pinna e bastone li dentro alle slot come nella foto. Assicurarsi che ogni pinna sia inserito e con la giusta angolazione al tubo del corpo per una corretta adesione. Ripetere con ogni pinna. Lasciate asciugare la colla.

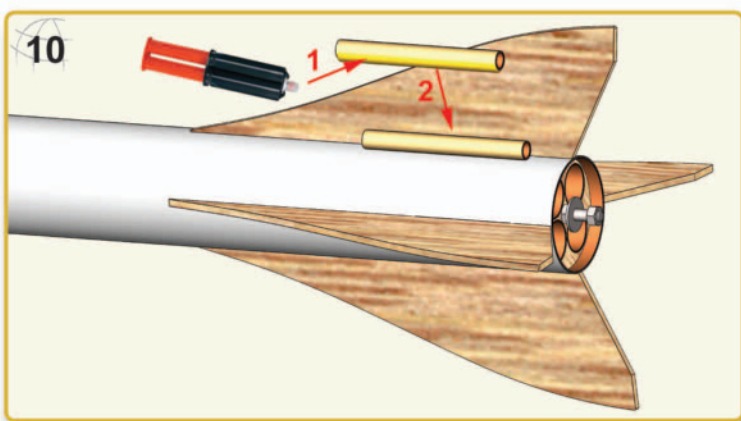

Deutsch Das Leitrohrchen in einer Ecke von Flosse und Körperrohr ankleben.

English Glue the launch lug in to the corner of one of the fins and body tube as shown.

Français Coller le tube de guidage dans l'angle d'une ailette et du tube comme indiqué.

Español Pegue la lengüeta de lanzamiento en la esquina de una de las aletas y tubo de cuerpo como se muestra.

Italiano Incollate la guida di lancio nell'angolo tra una delle alette e il tubo fusoliera, come indicato.

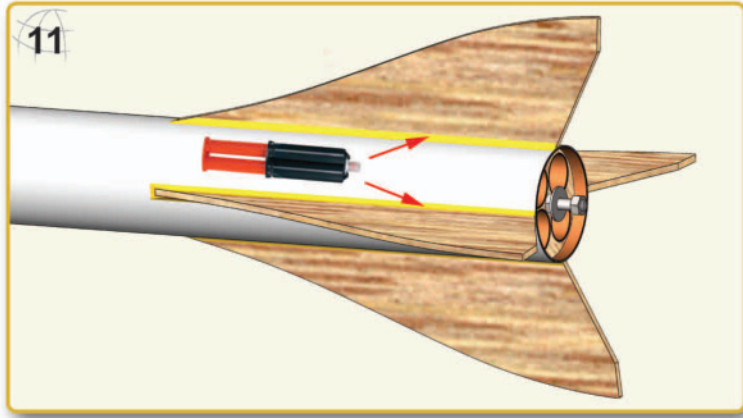

Deutsch Wenn der Klebstoff überall getrocknet ist, eine kleine Raupe mit Klebstoff in alle Fugen auftragen und mit einer feuchten Fingerkuppe glätten. Überschüssigen Klebstoff mit einem Papiertuch abwischen.

English After all glue has dried, apply a small bead of glue to all joints. Smooth the glue out with a wet fingertip. Wipe off the excess glue into a paper towel.

Français Après séchage, appliquer une petite goutte de colle sur tous les joints. Lisser la colle avec un doigt mouillé. Essuyer l'excès de colle à l'aide d'une serviette en papier.

Español Después de que todo el pegamento se haya secado, aplique un pequeño cordón de pegamento a todas las juntas. Suavizar el pegamento con un dedo mojado. Limpie el exceso de pegamento en una toalla de papel.

Italiano Dopo che la colla si è asciugata, applicate ancora un filetto di colla lungo tutte le giunzioni tra alette e tubo fusoliera. Lisciate il filetto di colla con un dito inumidito. Pulite la colla in eccesso con un fazzolettino di carta.

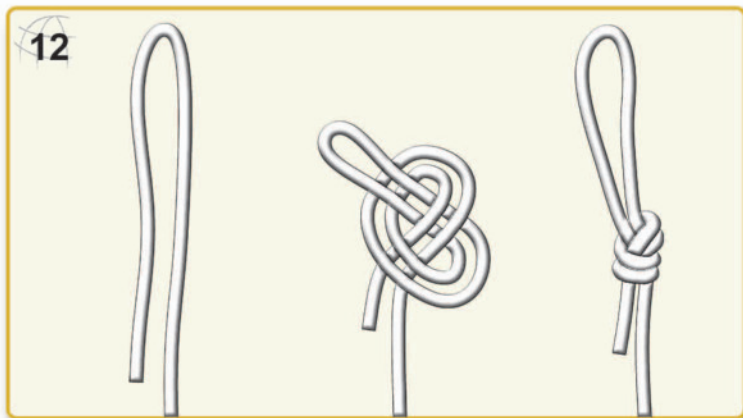

Deutsch In das elastische Schockband an beiden Enden eine Schlaufe binden.

English Tie a noose at both ends of the elastic shock cord.

Français Attachez un cordon aux deux extrémités du cordon amortisseur élastique.

Español Ate un lazo en ambos extremos del cordón de choque elástico.

Italiano Legare un cappio ad entrambe le estremità della cavo elastico.

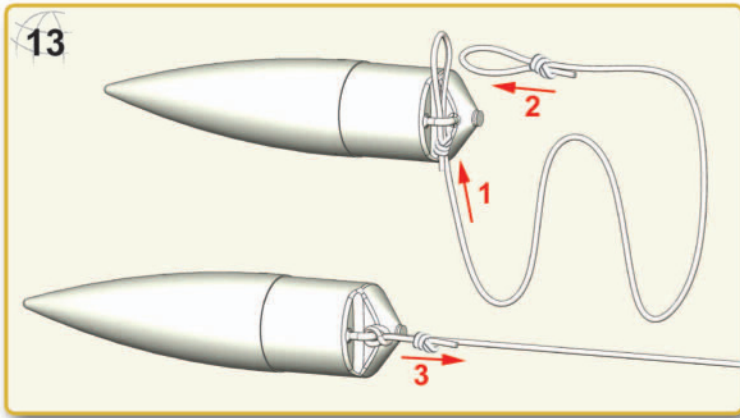

 Das Gummiseil wie dargestellt an der Spitze befestigen.

 Attach the elastic shock cord to the nose cone as pictured.

 Fixez le cordon amortisseur élastique sur l'ogive comme indiqué.

 Conecte el cordón de choque elástico al cono de la nariz como se ilustra.

 Legate il cavo elastico all'ogiva come illustrato.

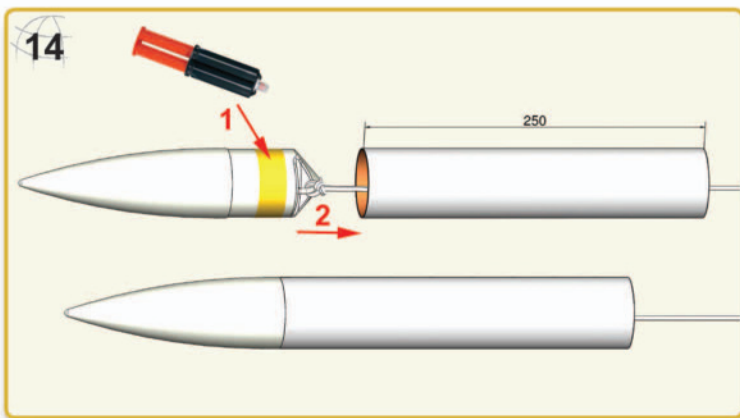

 Dann die Spitze im kurzen Körperrohr mit Epoxy einkleben.

 Glue the nose cone in to the shorter body tube.

 Coller l'ogive dans le tube de la fusée le plus court.

 Pegue el cono de la nariz en el tubo del cuerpo más corto.

 Incollare l'ogiva nel tubo corto.

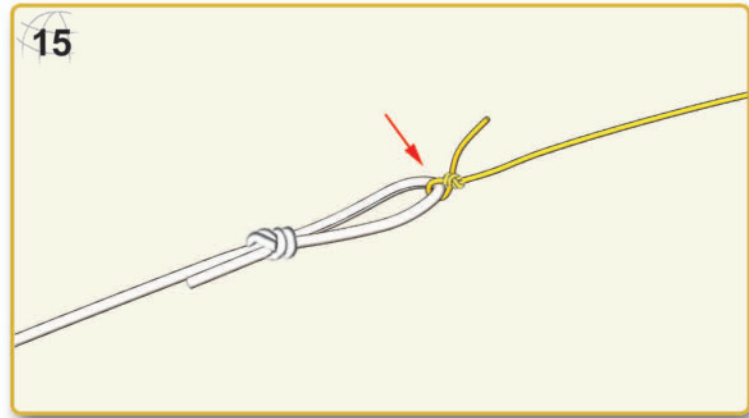

 Kevlarschnur und Gummiseil an einander festknoten.

 Tie the Kevlar cord and elastic cord together.

 Attacher le cordon Kevlar et le cordon élastique ensemble.

 Ate el cordón de Kevlar y el cordón elástico juntos.

 Legare il cavo di Kevlar e il cavo elastico insieme.

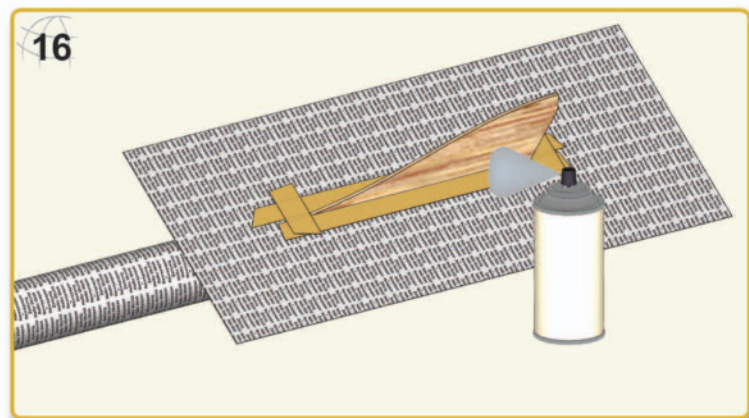

 Das Modell abschleifen, grundieren und entweder wie auf der Verpackung vorgeschlagen oder nach eigener Vorliebe lackieren. Die Flossen mit Kreppband und Zeitungspapier abdecken um sie in separaten Farben zu lackieren.

 Sand, prime and paint model as suggested on packaging or according to personal preference. Mask the fins with some masking tape and newspaper to paint them in separate colors.

 Sable, modèler premier et la peinture comme suggéré sur l'emballage ou selon vos préférences personnelles. Masquer les ailettes avec un peu de ruban de masquage et le journal de les peindre dans des couleurs distinctes.

 Arena, prima y pintar el modelo como se sugiere en el envase o de acuerdo a las preferencias personales. Enmascarar las aletas con un poco de cinta y el periódico para pintar en colores separados.

 Carteggiare tutto il modello con carta abrasiva fine (240) e coloratelo come suggerito sulla confezione, o in base alle vostre preferenze personali. Mascherate le alette con un po' di nastro adesivo e carta per dipingerle separatamente con colori diversi.

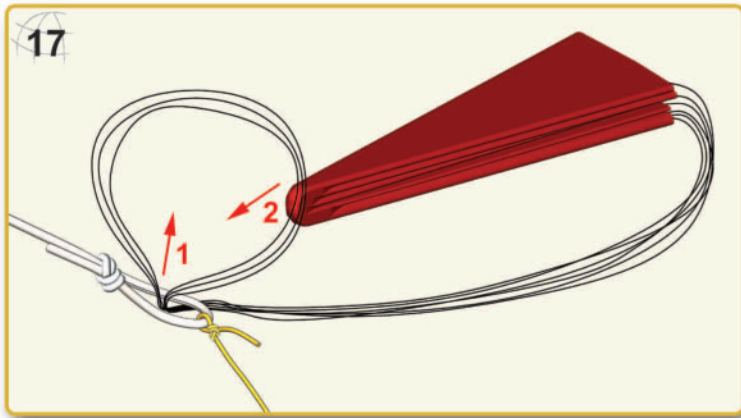

Germany Fädeln Sie die Schlaufen der Fallschirmleinen durch die Schlaufe des Gummiseils und ziehen Sie durch diese gemeinsame Schlaufe den Fallschirms hindurch. Die Leinen sollten etwa gleich lang sein.

United Kingdom Pass the shroud line loops of the pre-sewn parachute through the eyelet of the elastic cord. Pass parachute through the loop ends and pull lines tightly against the eyelet.

France Passer les boucles des suspentes du parachute pré-cousu à travers l'œillet du cordon élastique. Glisser le parachute à travers les extrémités de la boucle et tirer les lignes fermement contre l'œillet.

Spain Pase los bucles de la línea de protección del paracaídas pre-cosido a través del ojal del cordón elástico. Pase el paracaídas a través de los extremos del bucle y tire de las líneas firmemente contra el ojal.

Italy Passare le funicelle pre-cucite del paracadute attraverso l'occhiello dell'ogiva, dove è legato il cavo elastico. Passare il paracadute attraverso l'asola formata dalle funicelle e tirarle strettamente contro l'occhiello dell'ogiva.



Germany Die Aufkleber gemäß Abbildung anbringen. Eventuelle Luftblasen von innen nach außen streichen.

United Kingdom Apply stickers as shown on picture. Smooth out air bubbles from center to edge.

France Appliquer des autocollants comme indiqué sur la photo. Lisser les bulles d'air centre vers le bord.

Spain Aplicar pegatinas como se muestra en la foto. Suavice las burbujas de aire del centro al borde.

Italy Applicare le decal adesive come mostrato in figura. Eliminate le bolle d'aria premendo dal centro verso i bordi della decal.

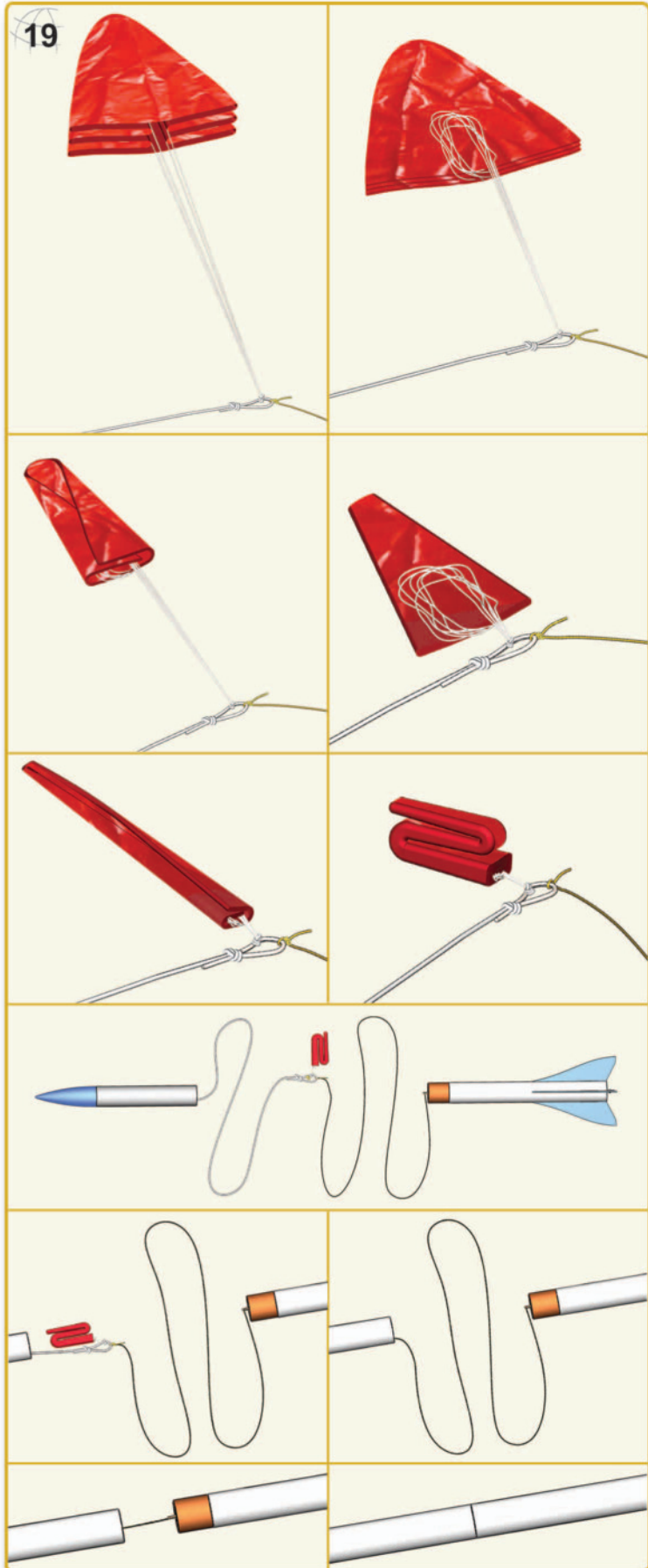

Germany Den Fallschirm gemäß der abgebildeten Schritte zusammenpacken.

United Kingdom Fold and pack the parachute according to the displayed steps.

France Pliez et emballez le parachute comme les étapes affichées.

Spain Doblar y embalar el paracaídas de acuerdo con los pasos que se muestran.

Italy Piegar e imballare il paracadute insieme come le istruzioni illustrate.